



TYROLPLAST
ROHRE - ARMATUREN - BEHÄLTERBAU
TUBI-RACCORDI-SERBATOI SU MISURA

I-39030 OBERVINTL / VANDOIES (BZ)
Tel. +39 0472 868140
Fax +39 0472 868130
e-mail: info@tyrolplast.it

HAWLE COMBI T E2 ART. 4340	
NW / DN	Preis/prezzo
80 - 80	690,19
100 - 80	758,14
100 - 100	835,42
125 - 80	930,03
125 - 100	959,33
150 - 80	919,38
150 - 100	980,67
150 - 150	1.411,04
200 - 80	1.215,17
200 - 100	1.284,43
200 - 150	1.721,47

HAWLE COMBI IV E2 ART. 4400		
NW / DN	Schieber/saracinesche	Preis/prezzo
80	2	
80	3	2.061,25
80	4	2.255,76
100	2	2.301,07
100	3	2.519,60
100	4	2.739,44
125	2	
125	3	3.537,55
125	4	3.889,30
150	2	3.548,21
150	3	3.899,95
150	4	4.251,73

HAWLE COMBI III E2 ART. 4450	
NW / DN	Preis/prezzo
80	1.680,18
80	1.874,69
100	1.965,31
100	2.185,15
125	2.556,90
125	2.908,66
150	2.963,28
150	3.315,02
200	4.996,54
200	5.528,16

NW / DN	Schieber/saracinesche	Preis/prezzo
80	2	1.680,18
80	3	1.874,69
100	2	1.965,31
100	3	2.185,15
125	2	2.556,90
125	3	2.908,66
150	2	2.963,28
150	3	3.315,02
200	2	4.996,54
200	3	5.528,16

HANDRAD für Schieber und Combi VOLANTINO per saracinesche e combi ART. 7800		
NW / DN	D	Preis/prezzo
3/4" - 2"	100	9,26
50	160	15,87
65	190	23,28
80	190	23,28
100	240	32,00
125-150	320	45,70
200	360	69,84
250-350	486	
400-500	600	

HANDRAD für Schieber und Combi VOLANTINO per saracinesche e combi ART. 780		
NW / DN	D	Preis/prezzo
3/4" - 2"		9,50
50	160	16,30
65	160	23,86
80	200	23,86
100	240	32,88
125-150	320	46,83
200	360	71,57
250-300-350	486	133,73
400-500	600	279,54



TYROLPLAST
ROHRE - ARMATUREN - BEHÄLTERBAU
TUBI-RACCORDI-SERBATOI SU MISURA

I-39030 OBERVINTL / VANDOIES (BZ)
Tel. +39 0472 868140
Fax +39 0472 868130
e-mail: info@tyrolplast.it

HAWLE SCHIEBER Art. A
SARACINESCA Art. A
PN 16



NW / DN	Preis/prezzo	NW / DN	Preis/prezzo
50	198,99	125	413,81
65	212,78	150	471,78
80	225,79	200	744,29
100	248,74	200 PN10	744,29



E2 Reduktions-SCHIEBER Art.4150E2
SARACINESCA di riduzione Art.4150E2

PN 16

NW / DN	Preis/prezzo	NW / DN	Preis/prezzo
80-100	458,35	100-125	657,68
80-150	612,66	100-150	715,52

HAWLE SCHIEBER / SARACINESCA
A CUNEO GOMMATO



ART. 4000E2

PN16

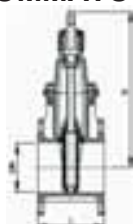

ART. 4010E2

PN25

NW / DN	Preis/prezzo	Preis/prezzo
50	245,90	378,42
65	322,64	442,37
80	336,00	483,15
100	421,68	567,49
125	605,07	904,70
150	720,77	989,98
200	1.103,23	1.393,71
250	1.925,76	
300	3.139,15	
350	5.871,92	
400	7.216,32	
500	11.890,42	
600	16.082,16	

HAWLE EINBAUGARNITUR
TELESKOPISCH FÜR SCHIEBER
UND COMBI - ARMATUREN
ASTA DI COMANDO TELESCOPICA

ART. 9500-E2

ART. 9500-A

NW / DN	Preis/prezzo	NW / DN	Preis/prezzo
50	120,19	50	
65	120,19	65	
80	120,19	80	123,22
100	120,19	100	123,22
125	147,82	125	123,22
150	147,82	150	123,22
200	156,70	200	123,22
250	188,69	250	
300	194,53	300	
350	203,98	350	
400-500		400-500	





TYROLPLAST
ROHRE - ARMATUREN - BEHÄLTERBAU
TUBI-RACCORDI-SERBATOI SU MISURA

I-39030 OBERVINTL / VANDOIES (BZ)
Tel. +39 0472 868140
Fax +39 0472 868130
e-mail: info@tyrolplast.it

HAWLE EINBAUGARNITUR
FÜR HAUSANSCHLUSSARMATUREN VON 3/4" BIS 2"
ASTA DI COMANDO PER VALVOLE DA 3/4" A 2"

ART. 9601
TELESKOPISCH
TELESCOPICA
L=1,3-1,8 m



Preis/prezzo

95,74

ART. 9101
STARR
FISSA
L=1,50 m



Preis/prezzo

50,50

HAWLE HAUSANSCHLUSS-ECKVENTILE
VALVOLE PER DERIVAZIONE ANGOLARE

MIT GEWINDEABGANG
CON ATTACCO D'USCITA FILETTATO
ART. 3120



NW / DN

Preis/prezzo

1"

136,11

1 1/4"

172,37

1 1/2"

196,98

2"

217,33

MIT PE-ANSCHLUSS
CON ATTACCO D'USCITA PER PE
ART. 3130



NW / DN

Preis/prezzo

32

146,93

40

172,94

50

201,70

63

223,44

HAWLE HAUSANSCHLUSSVENTIL
GERADE
SARACINESCA DIRITTA PER DERIVAZIONE

ART. 2500

NW / DN

Preis/prezzo

3/4"

154,32

1"

154,32

1 1/4"

185,74

1 1/2"

189,15

2"

241,34

HAWLE HAUSANSCHLUSSVENTIL
GERADE MIT SELBSTTÄT. ENTLERUNG
SARACINESCA DIRITTA PER DERIVAZIONE
CON SCARICO AUTOMATICO

ART. 2491

NW / DN

Preis/prezzo

3/4"

196,13

1"

196,13

1 1/4"

217,47

1 1/2"

226,85

2"

284,48



TYROLPLAST
ROHRE - ARMATUREN - BEHÄLTERBAU
TUBI-RACCORDI-SERBATOI SU MISURA

I-39030 OBERVINTL / VANDOIES (BZ)
Tel. +39 0472 868140
Fax +39 0472 868130
e-mail: info@tyrolplast.it

HAWLE STRASSENKAPPEN CHIUSINI STRADALI

ART.	Beschreibung/descrizione	Preis/prezzo
ART. 185 i	TELESKOPISCH - LEICHTES MODELL FÜR HAUSANSCHLUSSARMATUREN TELESCOPICO - TIPO LEGGERO PER PRESE	55,81
ART. 205 i	TELESKOPISCH - SCHWERES MODELL FÜR SCHIEBER TELESCOPICO - TIPO PESANTE PER SARACINESCHE	92,29



HAWLE SCHUBSICHERUNG FÜR PVC-ROHRE DISPOSITIVO ANTIFILAMENTO PER TUBI PVC



ART. 1254 = PN10
ART. 1255 = PN16

NW / DN	Ø	1254	1255
80	90	127,25	
100	110	141,58	
125	140		
150	160	223,90	
200	225	444,80	

HAWLE AUFSAZSPERRE RACCORDO FIL. PER PRESA S. CARICO



ART. 3720

NW / DN	Preis/prezzo
1"	50,67
1 1/4"	58,22
1 1/2"	66,48
2"	67,63

HAWLE ABSPERRSCHLÜSSEL CHIAVE DI MANOVRA

ART. 3410
FÜR HAUSANSCHLUSSARMATUREN 3/4" - 2"
PER VALVOLE 3/4" - 2"



Preis/prezzo

75,39

ART. 3420
FÜR SCHIEBER + UNTERFLURHYDRANTEN
PER SARACINESCHE E IDRANTI SOTTOSUOLO
DN 50 - 500



Preis/prezzo

127,90

HAWLE SPION LAMINA D'INTERCETTAZIONE

ART. 8401



TYP I
TYP II

1" - 1 1/4"

1 1/2" - 2"

Preis/prezzo

29,12

34,37



TYROLPLAST
ROHRE - ARMATUREN - BEHÄLTERBAU
TUBI-RACCORDI-SERBATOI SU MISURA

I-39030 OBERVINTL / VANDOIES (BZ)
Tel. +39 0472 868140
Fax +39 0472 868130
e-mail: info@tyrolplast.it



HAWLE ANBOHRSCHELLE HAKU FÜR PE- UND PVC-ROHRE
COLLARE DI PRESA HAKU CON DERIV. FIL. PER TUBI IN PE E PVC
ART. 5250

Ø	Preis/prezzo	Ø	Preis/prezzo
63 - 1"	73,34	180 - 1"	239,26
63 - 1 1/4"	73,34	180 - 1 1/4"	239,26
63 - 1 1/2"	73,34	180 - 1 1/2"	239,26
63 - 2"	73,34	180 - 2"	239,26
75 - 1"	80,34	200 - 1"	245,26
75 - 1 1/4"	80,34	200 - 1 1/4"	245,26
75 - 1 1/2"	80,34	200 - 1 1/2"	245,26
75 - 2"	80,34	200 - 2"	245,26
90 - 1"	81,31	225 - 1"	245,26
90 - 1 1/4"	81,31	225 - 1 1/4"	245,26
90 - 1 1/2"	81,31	225 - 1 1/2"	245,26
90 - 2"	81,31	225 - 2"	245,26
110 - 1"	99,87	250 - 1"	395,23
110 - 1 1/4"	99,87	250 - 1 1/4"	395,23
110 - 1 1/2"	99,87	250 - 1 1/2"	395,23
110 - 2"	99,87	250 - 2"	395,23
125 - 1"	146,82	280 - 1"	223,57
125 - 1 1/4"	146,82	280 - 1 1/4"	223,57
125 - 1 1/2"	146,82	280 - 1 1/2"	223,57
125 - 2"	146,82	280 - 2"	436,64
140 - 1"	146,82	315 - 1"	244,11
140 - 1 1/4"	146,82	315 - 1 1/4"	244,11
140 - 1 1/2"	146,82	315 - 1 1/2"	244,11
140 - 2"	146,82	315 - 2"	522,22
160 - 1"	162,38	400 - 1 1/2"	292,54
160 - 1 1/4"	162,38	400 - 2"	292,54
160 - 1 1/2"	162,38		
160 - 2"	162,38		

HAWLE ANBOHRGERÄT
ZUM ANBOHREN UNTER DRUCK

FORATUBI
PER FORARE SOTTOCARICO

ART. 5800



Preis/prezzo
4.610,77



TYROLPLAST
ROHRE - ARMATUREN - BEHÄLTERBAU
TUBI-RACCORDI-SERBATOI SU MISURA

I-39030 OBERVINTL / VANDOIES (BZ)
Tel. +39 0472 868140
Fax +39 0472 868130
e-mail: info@tyrolplast.it



HAWLE UNIVERSAL ANBOHRSCHELLE COLLARE DI PRESA UNIVERSALE



ART. 3500		ART. 3800	
NORMAL NORMALE		MIT SPERRSCHELLE	SOTTOCARICO
Ø	Preis/prezzo	Ø	Preis/prezzo
65 - 1"	104,16	50 - 1"	137,81
65 - 1 1/4"	104,16	50 - 1 1/4"	137,81
80 - 1"	101,74	65 - 1"	134,69
80 - 1 1/4"	101,74	65 - 1 1/4"	134,69
80 - 1 1/2"	101,74	80 - 1"	134,69
80 - 2"	101,74	80 - 1 1/4"	134,69
100 - 1"	103,01	80 - 1 1/2"	134,69
100 - 1 1/4"	103,01	80 - 2"	134,69
100 - 1 1/2"	103,01	100 - 1"	135,82
100 - 2"	103,01	100 - 1 1/4"	135,82
125 - 1"	117,26	100 - 1 1/2"	135,82
125 - 1 1/4"	117,26	100 - 2"	135,82
125 - 1 1/2"	117,26	125 - 1"	140,40
125 - 2"	117,26	125 - 1 1/4"	140,40
150 - 1"	118,45	125 - 1 1/2"	140,40
150 - 1 1/4"	118,45	125 - 2"	140,40
150 - 1 1/2"	118,45	150 - 1"	141,54
150 - 2"	118,45	150 - 1 1/4"	141,54
200 - 1"	137,23	150 - 1 1/2"	141,54
200 - 1 1/4"	137,23	150 - 2"	141,54
200 - 1 1/2"	137,23	200 - 1"	153,54
200 - 2"	137,23	200 - 1 1/4"	153,54
250 - 1"	148,11	200 - 1 1/2"	153,54
250 - 1 1/4"	148,11	200 - 2"	153,54
250 - 2"	148,11	250 - 1"	166,80
300 - 1"	151,81	250 - 1 1/4"	166,80
300 - 1 1/4"	151,81	250 - 1 1/2"	166,80
300 - 2"	151,81	250 - 2"	166,80
350 - 2"	311,09	300 - 1"	170,35
400 - 2"	335,41	300 - 1 1/4"	170,35
		300 - 1 1/2"	170,35
		300 - 2"	170,35
		350 - 1 1/2"	341,02
		350 - 2"	341,02
		400 - 1 1/2"	
		400 - 2"	349,63



TYROLPLAST
ROHRE - ARMATUREN - BEHÄLTERBAU
TUBI-RACCORDI-SERBATOI SU MISURA

I-39030 OBERVINTL / VANDOIES (BZ)
Tel. +39 0472 868140
Fax +39 0472 868130
e-mail: info@tyrolplast.it



HAWLE FLANSCHEN Art. 0400 FÜR PE- UND PVC-ROHRE

FLANGE HAWLE Art. 0400 PER TUBI IN PE E PVC

SPEZIALFLANSCH SCHUBGESICHERT FÜR PVC- UND PE- ROHRE
FLANGIA SPECIALE ANTISFILAMENTO PER TUBI IN PVC E PE

NW/DN	Ø	Preis/prezzo	NW/DN	Ø	Preis/prezzo
50	63	86,69	200 PN10	200	353,09
65	63	113,70	200 PN16	200	324,85
65	75	94,11	200 P010	225	353,09
80	75	119,02	200 PN16	225	353,09
80	90	109,49	250 PN10	250	541,78
100	90	133,15	250 PN16	250	498,43
100	110	122,50	250 PN10	280	587,95
100	125	138,13	250 PN16	280	540,91
125	110	162,24	300 PN10 PN16	315	777,17
125	125	157,49	300 PN16 PN16	355	1.948,88
125	140	157,49	400 PN10 PN16	400	3.241,95
150	140	191,81	400 PN10 PN16	450	3.449,09
150	160	191,81			
150	180	247,52			

ART. 8075

HAWLE ENDKAPPE mit Gewindeanschluss
HAWLE TAPPO DI ESTREMITA' CON INNESTO
ANTISFILAMENTO

	Ø	Preis/prezzo
	63	104,02
	75	110,10
	90	119,02
	110	141,92
	125	169,18
	140	175,06
	160	206,34
	180	273,79
	200	354,53
	225	353,12
	250	505,76
	280	566,30
	315	678,22



C 084 EINKLEMM - RÜCKSCHLAGKLAPPE VALVOLA DI RITEGNO INSERIBILE TRA FLANGE

NW/DN	Preis/prezzo
50	49,50
80	76,50
100	94,50
125	129,38
150	190,13

SCHMUTZFÄNGER RACC. IMPURITA'

* Auslaufmodell







NW/DN	ART. 9910 *	ART. 9911
50		
65		495,50
80		495,50
100		680,50
125	976,61	
150		1.333,82
200		

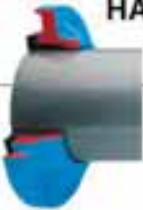

TYROLPLAST
ROHRE - ARMATUREN - BEHÄLTERBAU
TUBI-RACCORDI-SERBATOI SU MISURA

I-39030 OBERVINTL / VANDOIES (BZ)
Tel. +39 0472 868140
Fax +39 0472 868130
e-mail: info@tyrolplast.it

HAWLE FLANSCHEN FÜR STAHLROHRE FLANGE PER TUBI IN ACCIAIO											
			ART. 7101						ART. 7601		
			ZWEIKAMMERSPEZIALFLANSCH FLANGIA BICONICA						ZWEIKAMMERSPEZIALFLANSCH SCHUBGESICHERT FLANGIA SPEC. ANTISFILAMENTO		
NW/DN	Ø	Preis/prezzo	NW/DN	Ø	Preis/prezzo	NW/DN	Ø	Preis/prezzo			
50	59-61	52,80	50	60,30	116,50	50	60,30	116,50			
65	76,10	75,55	65	76,10	125,02	65	76,10	125,02			
80	89,00	81,41	80	88,90	140,16	80	88,90	140,16			
100	108,00	88,98	100	108,00	157,58	100	108,00	157,58			
100	114,30	90,03	100	114,30	153,74	100	114,30	153,74			
125	133,00	131,12	125	133,00	208,51	125	133,00	208,51			
150 (A5600)	159,00	125,74	150	159,00	314,05	150	159,00	314,05			
200	219,10	212,53	150	168,30	307,57	150	168,30	307,57			
300	316,00		200	219,10	472,51	200	219,10	472,51			

HAWLE FLANSCHEN FÜR GUSSROHRE FLANGE PER TUBI IN GHISA											
			ART. 7102						ART. 7602		
			ZWEIKAMMERSPEZIALFLANSCH FLANGIA BICONICA						ZWEIKAMMERSPEZIALFLANSCH SCHUBGESICHERT FLANGIA SPEC. ANTISFILAMENTO		
NW/DN	Ø	Preis/prezzo	NW/DN	Ø	Preis/prezzo	NW/DN	Ø	Preis/prezzo			
50	66	52,80	50	66	120,66	50	66	120,66			
65	82	73,73	60	77	120,66	65	82	131,89			
80	98	53,71	65	82	131,89	80	98	131,89			
100	118	65,26	80	98	131,89	100	118	148,51			
125	144	77,57	100	118	148,51	125	144	195,74			
150	170	106,94	125	144	195,74	150	170	289,87			
200 PN10 PN16	222	155,71	150	170	289,87	200 PN10 PN16	222	438,61			
250 PN10 PN16	273-274	288,18	200 PN10 PN16	222	438,61	250 PN10 PN16	274	537,15			
300 PN10 PN16	326	320,11	250 PN10 PN16	274	537,15	300 PN10 PN16	326	600,24			
400 PN10 PN16	429	988,30	300 PN10 PN16	326	600,24						

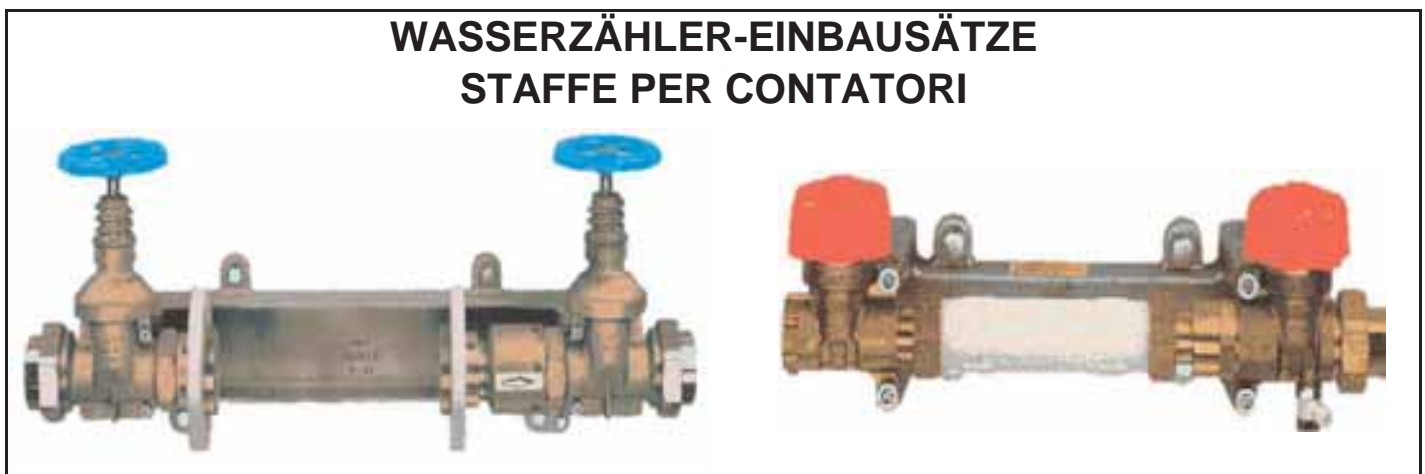



TYROLPLAST
ROHRE - ARMATUREN - BEHÄLTERBAU
TUBI-RACCORDI-SERBATOI SU MISURA

I-39030 OBERVINTL / VANDOIES (BZ)
Tel. +39 0472 868140
Fax +39 0472 868130
e-mail: info@tyrolplast.it

HAWLE BE- UND ENTLÜFTUNGSVENTILE SFIATO AERATORE AUTOMATICO



ART. 9876

NW/DN	Ø	Preis/prezzo
1" - PN 0,1 - 6	50	173,62
2" - PN 0,1 - 6	63	426,62
1" - PN 1 - 16	50	173,62
2" - PN 1 - 16	63	406,85



RACI TDR

NW/DN	PN	Preis/prezzo
50	16	384,18
60-65	16	384,18
80	16	526,80
100	16	771,12
150	16	2.231,47
50	25	418,59
80	25	646,40
100	25	810,19
150	25	2.138,24

HAWLE BOGEN 90° FÜR PE-ROHRE CURVE 90° PER TUBI IN PE

ART. 8535

absolut zugfest
antisfilamento



NW/DN	Ø	Preis/prezzo
50	63	150,85
65	75	159,65
80	90	171,02
100	110	193,23
125	125	270,62
125	140	361,66
150	160	410,77
150	180	589,39
200	200	760,02
200	225	779,81
250	250	1.136,06
250	280	1.431,63
300	315	1.803,73

HAWLE HYDRANTENFUSS FÜR PE- UND PVC-ROHRE BIS PN16 PIEDINO PER IDRANTE PER TUBI IN PE AD E PVC PN16

ART. 5045



ROHR Ø	FLANSCH/FLANGIA NW/DN	Preis/prezzo
90	80	231,12
110	80	257,47
110	100	265,47

HAWLE VERBINDER FÜR PE- UND PVC-ROHRE BIS PN16 ART. 430 RACCORDO PER TUBI IN PE E PVC FINO A PN 16 ART. 430

ROHR Ø TUBO	Preis/prezzo	ROHR Ø TUBO	Preis/prezzo
63	128,82	180	390,56
75	139,47	200	515,90
90	163,54	225	597,98
110	172,32	250	777,17
125	212,82	280	953,98
140	237,74	315	1.179,60
160	280,80	355	3.355,42





TYROLPLAST
ROHRE - ARMATUREN - BEHÄLTERBAU
TUBI-RACCORDI-SERBATOI SU MISURA

I-39030 OBERVINTL / VANDOIES (BZ)
Tel. +39 0472 868140
Fax +39 0472 868130
e-mail: info@tyrolplast.it

HAWLE MMA-STÜCK FÜR PE-ROHRE MMA PER TUBI IN PE



ART. 8525

absolut zugfest
antisfilamento

Ø	NW/DN	Preis/prezzo
90	80	276,03
110	50	271,04
110	80	280,26
110	100	305,46
125	80	324,19
125	100	347,28
140	80	358,78
140	100	367,47
140	125	400,59
160	80	390,56
160	100	403,49
160	150	438,08
180	80	527,38
180	150	623,98
200	200	911,76
225	80	712,51
225	100	753,41
225	200	1.017,31

HAWLE MMB-STÜCK FÜR PE-ROHRE MMB PER TUBI IN PE







ART. 8515

absolut zugfest
antisfilamento

Ø	Ø	Preis/prezzo
63	63	218,74
75	75	246,10
90	90	271,15
110	63	277,76
110	90	291,07
110	110	289,63
125	90	345,84
125	110	348,75
125	125	364,59
140	90	377,50
140	110	373,28
140	140	428,05
160	90	417,87
160	110	404,96
160	160	478,45
180	125	566,30
180	180	687,46
200	200	1.017,31
225	90	
225	110	
225	225	

HAWLE NEWS H4-NIRO-Umfahrhydrant mit Fallmantel IDRANTI HAWLE

<i>H4-Überflurhydranten "NIRO"</i>		<i>H4-Überflurhydranten "GUSS"</i>	
			



TYROLPLAST
ROHRE - ARMATUREN - BEHÄLTERBAU
TUBI-RACCORDI-SERBATOI SU MISURA

I-39030 OBERVINTL / VANDOIES (BZ)
Tel. +39 0472 868140
Fax +39 0472 868130
e-mail: info@tyrolplast.it



MUFFE 1	MUFFE 2	PN	Muffe 1			Muffe 2			L	kg	Preis
DN	DN		B	H	Rohr D3 min / max	B	H	Rohr D3 min / max			Prezzo
40	40	16	130	157	46-56	130	157	46-58	243	3,9	
50	50		141	170	56-71	141	170	56-71	253	5,0	237,58
65	65		156	187	71-88	156	187	71-88	264	5,6	330,27
80	65		171	204	85-105	156	187	71-88	274	6,2	342,58
80	80		171	204	85-105	171	204	85-105	270	6,5	343,82
100	80		226	260	104-132	171	204	85-105	312	9,5	369,68
100	100		226	260	104-132	226	260	104-132	332	11,7	362,26
125	100		250	290	131-160	226	260	104-132	355	13,7	
125	125		250	290	131-160	250	290	131-160	357	14,5	594,05
150	100		315	350	155-192	226	260	104-132	361	16,2	540,96
150	125		315	350	155-192	250	290	131-160	375	17,4	
150	150		315	350	155-192	315	350	155-192	367	18,7	619,90
200	200		326	405	198-230	326	405	198-230	406	31,1	
225	200		361	445	230-260	326	405	198-230	450	38,8	
225	225		361	445	230-260	361	445	230-260	429	41,8	991,95
250	200		408	499	265-310	326	405	198-230	468	45,6	
250	250	408	499	265-310	408	499	265-310	441	51,0	1.434,82	
300	300	510	545	313-356	510	545	313-356	460	68,0	1.810,64	
350	350	10	550	550	352-396	550	550	352-396	499	86,0	
400	400	10	596	596	398-442	596	596	398-442	519	100,0	

Die Hawle Synoflex Muffenverbindung ist für die zugfeste Verbindung aller gängigen Rohrarten in der Wasserversorgung geeignet.

Verbinden Sie die verschiedensten Rohre (AZ, Guss, PE, PVC, Stahl) korrosionsgeschützt und höchstqualitativ mit Hilfe des patentierten Hawle Synoflex

Hawle Synoflex und die darin eingebauten Komponenten werden auf High-Tech-Sondermaschinen produziert. In eigenen Labors werden bereits die Rohstoffe sowie die Einzelteile und auch das fertige Produkt sorgfältigen Qualitätsprüfungen unterzogen.

Das macht eine HAWLE Synoflex zugfeste Mehrbereichsverbindung in ihrer Qualität und Passgenauigkeit einzigartig am Markt.



TYROLPLAST
 ROHRE - ARMATUREN - BEHÄLTERBAU
 TUBI-RACCORDI-SERBATOI SU MISURA

I-39030 OBERVINTL / VANDOIES (BZ)
 Tel. +39 0472 868140
 Fax +39 0472 868130
 e-mail: info@tyrolplast.it

HAWLE SYNOFLEX Flansch ART. 7994

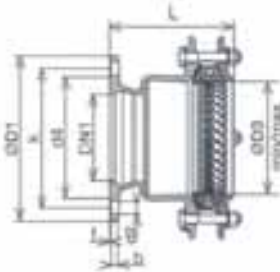
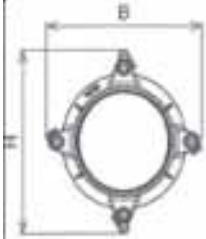



Flansch DN 1	MUFFE 2 DN	PN	Flansch					B	H	Rohr D3 min / max	L	kg	Preis Prezzo
			D1	b	k	d4	f						
50	50	10	165	14	125	98	4	141	170	56-71	203	5,1	191,38
		16											
65	65	10	185	14	145	118	4	156	187	71-88	203	6,1	251,38
		16											
80	65	10	198	14	160	133	4	156	187	71-88	203	6,3	267,39
		16											
80	80	10	198	14	160	133	4	171	204	85-105	193	6,7	274,80
		16											
80	100	10	198	14	160	133	4	226	260	104-132	263	10	316,74
		16											
100	80	10	220	14	180	153	4	171	204	85-105	188	7,3	303,17
		16											
100	100	10	220	14	180	153	4	226	260	104-132	228	10,3	316,74
		16											
100	125	10	220	14	180	153	4	250	290	131-160	278	12,5	473,22
		16											
125	125	10	250	14	210	183	4	250	290	131-160	248	12,9	470,82
		16											
150	125	10	285	14	240	209	4	250	290	131-160	245	13,8	478,22
		16											
150	150	10	285	14	240	209	4	315	350	155-192	258	16,5	478,22
		16											
200	200	10	340	15	295	264	4	326	405	198-230	277	25,4	704,14
		16											
200	225	10	340	15	295	264	4	361	445	230-260	322	32,8	779,57
		16											
250	250	10	400	16	350	319	4	408	499	265-310	335	42,7	1.053,41
		16											
300	300	10	455	18	400	367	4	510	545	313-356	353	59,1	1.282,54
		16											
350	350	10	520	20	460	427	4	550	550	352-396	358	71,0	
		16											
400	400	10	580	21	515	477	4	596	596	398-442	373	83	
		16											



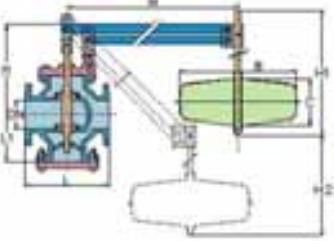

TYROLPLAST
ROHRE - ARMATUREN - BEHÄLTERBAU
TUBI-RACCORDI-SERBATOI SU MISURA

I-39030 OBERVINTL / VANDOIES (BZ)
Tel. +39 0472 868140
Fax +39 0472 868130
e-mail: info@tyrolplast.it

FLANSCHENSCHIEBER MIT HANDRAD		SARACINESCHE CON VOLANTINO		
		GRAUGUSS GHISA		STAHLGUSS ACCIAIO
	NW-DN	PN 10/16	PN 40	PN 64
	50		379,20	566,67
	65		480,32	694,79
	80		602,22	865,61
	100		758,48	1.128,41
	125	AUF ANFRAGE	988,77	1.732,85
	150		1.407,83	2.269,94
	200		2.829,38	4.498,82
	250		5.540,52	6.377,84
300		7.367,63	9.809,01	

SCHWIMMERVERVENTILE PN16 AUS GG MIT INOXKUGEL		VALVOLE A GALLEGGIANTE PN16 IN GG CON SFERA IN ACCIAIO INOX	
	NW-DN		Preis/prezzo
	50		AUF ANFRAGE SU RICHIESTA
	65		
	80		
	100		
	125		
	150		
200			

PLATTENSCHIEBER Typ WAFER VALVOLE A FARFALLA tipo WAFER			PLATTENSCHIEBER TYP LUG VALVOLE A FARFALLA tipo LUG		
	bis DN 150 PN16 ab DN 200 PN10 fino DN150 PN16 dal DN 200 PN10 ab DN 250 mit Antrieb und Handrad dal DN 250 complete di riduttore di sforzo e volantino				
	Platte-lente Inox	Platte-lente in GG		Platte-lente Inox	
Preis/prezzo	Preis/prezzo			Preis/prezzo	Preis/prezzo
Art. D106	Art. D104	NW-DN	NW-DN	Art. D116	Art. D114
48,38	38,25	50	50	53,85	51,75
60,75	47,25	65	65	64,13	58,50
70,88	51,75	80	80	78,75	64,13
99,00	69,75	100	100	126,00	99,00
140,63	95,63	125	125	168,75	120,38
181,13	110,25	150	150	210,38	137,25
297,00	172,13	200	200	408,38	247,50
564,75	415,13	250	250	742,50	513,00
814,50	459,00	300	300	1.107,00	579,38
auf Anfrage / a richiesta	auf Anfrage / a richiesta	350	350	auf Anfrage / a richiesta	auf Anfrage / a richiesta
auf Anfrage / a richiesta	auf Anfrage / a richiesta	400	400	auf Anfrage / a richiesta	auf Anfrage / a richiesta
auf Anfrage / a richiesta	auf Anfrage / a richiesta	500	500	auf Anfrage / a richiesta	auf Anfrage / a richiesta
auf Anfrage / a richiesta	auf Anfrage / a richiesta	600	600	auf Anfrage / a richiesta	auf Anfrage / a richiesta



TYROLPLAST
ROHRE - ARMATUREN - BEHÄLTERBAU
TUBI-RACCORDI-SERBATOI SU MISURA

I-39030 OBERVINTL / VANDOIES (BZ)
Tel. +39 0472 868140
Fax +39 0472 868130
e-mail: info@tyrolplast.it

LÜFTUNGSVENTILE TYP SIENA SFIATI TIPO SIENA

	NW-DN	PN 10/16	PN 25	PN 40	PN 64
	50	156,74	156,74	156,74	348,87
	65	242,69	342,35	342,35	AUF ANFRAGE A RICHIESTA
	80	281,48	378,23	378,23	
	100	316,79	419,45	419,45	
	150	435,83	643,62	643,62	
	200	732,38	1.044,23	1.178,10	

LÜFTUNGSVENTILE DOPPELTER SCHWIMMER SFIATI A DOPPIO GALLEGGIANTE

	NW-DN	PN 10/16	PN 25	PN 40	PN 64
	50	203,45	203,45	203,45	415,71
	80	324,27	499,41	499,41	649,47
	100	371,03	555,08	555,08	786,60
	150	575,99	935,33	935,33	
	200	896,58	1.372,67	1.491,47	
	250	1.650,38	2.321,87	2.666,37	
	300	2.126,82	3.061,92	3.368,03	

RÜCKSCHLAGKLAPPEN VALVOLE DI RITEGNO

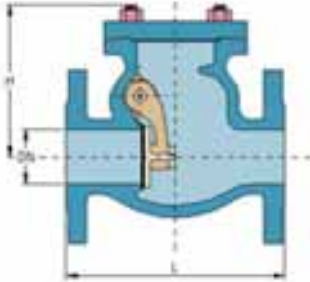
			GRAUGUSS/GHISA	STAHLGUSS/ACC.
	NW-DN	PN 10/16	PN 40	
	50	256,23	275,94	
	65	318,65	348,21	
	80	431,99	489,47	
	100	563,39	657,00	
	125	722,70	883,67	
	150	982,22	1.161,26	
	200	1.511,10	2.085,98	
	250	2.425,98		

RÜCKFLUSSSPERREN TYP VENTURI VALVOLE DI RITEGNO TIPO VENTURI

			GRAUGUSS/GHISA			STAHLGUSS/ACC.
	NW-DN	PN 10/16	PN 25	PN 40	PN 64	
	50	180,99	180,99	180,99	362,15	
	65	225,75	328,77	370,49	540,12	
	80	302,66	429,57	502,83	629,81	
	100	400,59	600,53	662,93	855,71	
	125	501,11	817,70	903,32	1.134,00	
	150	706,77	1.070,49	1.183,14	1.754,45	
	200	1.167,89	2.133,90	2.520,59	3.444,60	
	250	2.045,97	3.210,11	5.390,96	6.726,00	
	300	2.797,25	4.727,12	7.121,10	8.802,12	



TYROLPLAST
ROHRE - ARMATUREN - BEHÄLTERBAU
TUBI-RACCORDI-SERBATOI SU MISURA

I-39030 OBERVINTL / VANDOIES (BZ)
Tel. +39 0472 868140
Fax +39 0472 868130
e-mail: info@tyrolplast.it

HOCHDRUCK KOLBENDRUCKMINDERER DRV 225 PN40 VORDRUCK BIS 40 BAR HINTERDRUCK (einstellbar) 1,5 BIS 20 BAR Größtes Reduktionsverhältnis 6:1 RIDUTTORE DI PRESSIONE DRV 225 PN40 PRESSIONE A MONTE 40 BAR A VALLE 1,5-20 BAR					DRV 225			
DN 8 1/4"	DN 10 3/8"	DN 15 1/2"	DN 20 3/4"	DN 25 1"	DN 32 1 1/4"	DN 40 1 1/2"	DN 50 2"	
236,25	236,25	305,10	379,35	553,50	751,95	927,45	1.229,85	

HOCHDRUCK KOLBENDRUCKMINDERER DRV 226 PN60 VORDRUCK BIS 60 BAR HINTERDRUCK (einstellbar) 20 BIS 45 BAR Größtes Reduktionsverhältnis 3:1 RIDUTTORE DI PRESSIONE DRV 226 PN60 PRESSIONE A MONTE 60 BAR A VALLE 20-45 BAR				DRV 226			
DN 8 1/4"	DN 10 3/8"	DN 15 1/2"	DN 20 3/4"				
263,25	263,25	418,50	445,50				

DRUCKMINDERER GEWINDEANSCHLUSS DRV 403 PN16 VORDRUCK BIS 16 BAR HINTERDRUCK (einstellbar) 1,5 BIS 6 BAR Mindestdruckgefälle ca. 1 bar RIDUTTORE DI PRESSIONE ATT. FIL. DRV 403 PN16 PRESSIONE A MONTE 16 BAR A VALLE 1,5-6 BAR				DRV 403			
DN 10 3/8"	DN 15 1/2"	DN 20 3/4"	DN 25 1"	DN 32 1 1/4"			
76,35	101,06	119,07	135,00	205,20			



DRUCKMINDERER GEWINDEANSCHLUSS DRV 408 PN25 VORDRUCK BIS 25 BAR HINTERDRUCK (einstellbar) 1,5 BIS 10 BAR Mindestdruckgefälle ca. 1 bar RIDUTTORE DI PRESSIONE ATT. FIL. DRV 408 PN25 PRESSIONE A MONTE 25 BAR A VALLE 1,5-10 BAR				DRV 408			
DN 15 1/2"	DN 20 3/4"	DN 25 1"	DN 32 1 1/4"	DN 40 1 1/2"	DN 50 2"	DN 65 2 1/2"	
101,06	119,07	135,00	205,20	411,75	445,50	738,45	





TYROLPLAST
ROHRE - ARMATUREN - BEHÄLTERBAU
TUBI-RACCORDI-SERBATOI SU MISURA

I-39030 OBERVINTL / VANDOIES (BZ)
Tel. +39 0472 868140
Fax +39 0472 868130
e-mail: info@tyrolplast.it

HOCHDRUCK KOLBENDRUCKMINDERER DRV 424 PN25 (alte Typenbezeichnung DRV 403-H) VORDRUCK 25 BAR HINTERDRUCK (einstellbar) 1,5 BIS 12 BAR Mindestdruckgefälle ca. 1 bar RIDUTTORE DI PRESSIONE DRV 424 PN25 PRESSIONE A MONTE 25 BAR A VALLE 1,5-12 BAR					DRV 424 			
DN 10 3/8"	DN 15 1/2"	DN 20 3/4"	DN 25 1"	DN 32 1 1/4"	DN 40 1 1/2"	DN 50 2"	DN 65 2 1/2"	
	133,52	143,10	155,25	234,90	449,55	517,05	753,30	

DRUCKMINDERER DRV 502 PN25 / DRV 602 PN16 (alte Typenbezeichnung DRV 411) VORDRUCK BIS 25 (16) BAR HINTERDRUCK (einstellbar) 1,5 BIS 6 BAR Mindestdruckgefälle ca. 1 bar RIDUTTORE DI PRESSIONE DRV 502 PN25 / DRV 602 PN16 PRESSIONE A MONTE 25 (16) BAR A VALLE 1,5-6 BAR					 DN 40-DN 80 DRV502 PN25		 DN 80 - DN 125 DRV602 PN16	
DN 25	DN 32	DN 40	DN 50	DN 65	DN 80 DIN	DN 80	DN 100	DN 125
DRV 502 PN25	DRV 502 PN25	DRV 502 PN25	DRV 502 PN25	DRV 502 PN25	DRV 502 PN25	DRV602 PN16	DRV602 PN16	DRV602 PN16
521,10	596,70	683,10	893,70	1.212,30	1.794,15	1.794,15	2.852,55	4.372,65

DRUCKMINDERER DRV 524 PN25 / DRV 624 PN25 (alte Typenbezeichnung DRV 414) VORDRUCK BIS 25 BAR HINTERDRUCK (einstellbar) 1,5 (4) BIS 12 BAR Mindestdruckgefälle ca. 1 bar RIDUTTORE DI PRESSIONE DRV 524 PN 25 / DRV 624 PN25 PRESSIONE A MONTE 25 BAR A VALLE 1,5 (4)-12 BAR					 DN 40 - DN 80 DRV524		 DN 80 - DN 100 DRV624	
DN 20	DN 25	DN 32	DN 40	DN 50	DN 65	DN 80	DN 80	DN 100
DRV 524 PN25	DRV 524 PN25	DRV 524 PN25	DRV 524 PN25	DRV 524 PN25	DRV 524 PN25	DRV 524 PN25	DRV 624 PN25	DRV 624 PN25
498,15	557,55	653,40	1.084,05	1.192,05	1.625,40	1.657,80	2.332,80	3.654,45



TYROLPLAST
 ROHRE - ARMATUREN - BEHÄLTERBAU
 TUBI-RACCORDI-SERBATOI SU MISURA

I-39030 OBERVINTL / VANDOIES (BZ)
 Tel. +39 0472 868140
 Fax +39 0472 868130
 e-mail: info@tyrolplast.it

SYSTEM FÜR TELEMATISCHES ABLESEN DER WASSERZÄHLER "MADDALENA"
SISTEMA TELELETTURA CONTATORI "MADDALENA"



SENDER MODULO RADIO

Art. cod.	MOD.	PREIS/PREZZO
1.ETRYH.0018	ARROW DP	132,00



EMPFANGGERÄT RICEVITORE RADIO

Art. cod.	MOD.	PREIS/PREZZO
1.ETRYH.0016	ARROW PRT	3.400,00



PALM TERMINALE PALMARE

Art. cod.	MOD.	PREIS/PREZZO
1.ETRYH.003	ARROW iPAQ	2.000,00



INFRAROTKABEL INTERFACCIA OTTICA (OPZIONALE) INFRAROSSI

Art. cod.	MOD.	PREIS/PREZZO
1.ETRYH.019	ARROW IrDA	800,00



SOFTWARE PALM SOFTWARE PALMARE

Art. cod.	MOD.	PREIS/PREZZO
1.ETRYH.012	ARROW MOB.	2.000,00



Unser System Arrow ermöglicht Ablesung der Kaltwasser-, Warmwasser- und Gaszähler auf Distanz und stellt Ihnen erhobene Daten für weitere Analysen (Wasserbilanzen, Rohrbruchsuche, usw.) und Verrechnung zur Verfügung. Die Ablesung auf Distanz ist ein erheblicher Vorteil vor allem bei schwer zugänglichem Zähler.

Besichtigung von bestehenden Anlagen nach Terminvereinbarung möglich.

I nostri sistemi Arrow permettono la lettura a distanza di contatori per acqua, gas e calore rendendo disponibili i dati acquisiti per sistemi di analisi (bilanci idrici, ricerca perdite, etc.), fatturazione o altro. La lettura a distanza del contatore è di notevole vantaggio in tutti quei casi in cui l'accesso al contatore si presenta difficile o problematico.

Su appuntamento Vi facciamo visitare impianti in funzione.



TYROLPLAST
ROHRE - ARMATUREN - BEHÄLTERBAU
TUBI-RACCORDI-SERBATOI SU MISURA

I-39030 OBERVINTL / VANDOIES (BZ)
Tel. +39 0472 868140
Fax +39 0472 868130
e-mail: info@tyrolplast.it

BESCHREIBUNG INDICE	
TRP = Turbine - Trockenläufer TRP = Turbina - rulli protetti - lettura diretta su rulli numerati	
S/D = Turbine - Super Trockenläufer S/D = Turbina - Super Dry - lettura diretta su rulli numerati	

WASSERZÄHLER "MADDALENA" TROCKENLÄUFER CD ONE TRP CL. B
CONTATORI "MADDALENA" A TURBINA A GETTO UNICO A RULLI PROTETTI CD ONE TRP CL. B

Art. cod.	NW DN	QN m ³ /h	MOD.	TEMP. °C	Länge/lunghezza mm	PREIS/PREZZO	
CDONE3.06P6	1/2"	1,5	CD ONE TRP	30	110	31,00	
CDONE5.06RD	3/4"	2,5	CD ONE TRP	30	130	39,00	
CDONE7.06RU	1"	3,5	CD ONE TRP	30	160	65,50	
CDONE10.06RC	1 1/4"	5	CD ONE TRP	30	160	70,30	
CDONE3.07B4	1/2"	1,5	CD ONE TRP	90	110	40,00	
CDONE5.07SP	3/4"	2,5	CD ONE TRP	90	130	50,60	
CDONE7.06RM	1"	3,5	CD ONE TRP	90	160	67,00	
CDONE10.06RN	1 1/4"	5	CD ONE TRP	90	160	90,00	
AUFPREIS VORBEREITUNG IMPULSGEBER REED-SWITCH				SOVRAPPREZZO PER PREDISPOSIZIONE LANCIAMPULSI REED-SWITCH			7,50
AUFPREIS FÜR SENDER IMPULSE REED-SWITCH				SOVRAPPREZZO PER EMETTITORE DI IMPULSI REED-SWITCH			11,50
AUFPREIS FÜR SENDER IMPULSE QuadraPlus				SOVRAPPREZZO PER EMETTITORE DI IMPULSI statico QuadraPlus			52,00

WASSERZÄHLER "MADDALENA" TROCKENLÄUFER CD ONE TRP CL. C
CONTATORI "MADDALENA" A TURBINA A GETTO UNICO A RULLI PROTETTI CD ONE TRP CL. C

Art. cod.	NW DN	QN m ³ /h	MOD.	TEMP. °C	Länge/lunghezza mm	PREIS/PREZZO	
CDONE3.OAII	1/2"	2,5	CD ONE TRP	30	110	38,50	
CDONE5.OAHF	3/4"	4,0	CD ONE TRP	30	130	48,70	
CDONE7.OAHF	1"	6,3	CD ONE TRP	30	160	83,00	
AUFPREIS VORBEREITUNG IMPULSGEBER REED-SWITCH				SOVRAPPREZZO PER PREDISPOSIZIONE LANCIAMPULSI REED-SWITCH			7,50
AUFPREIS FÜR SENDER IMPULSE REED-SWITCH				SOVRAPPREZZO PER EMETTITORE DI IMPULSI REED-SWITCH			11,40
AUFPREIS FÜR SENDER IMPULSE QuadraPlus				SOVRAPPREZZO PER EMETTITORE DI IMPULSI statico QuadraPlus			52,00



TYROLPLAST
 ROHRE - ARMATUREN - BEHÄLTERBAU
 TUBI-RACCORDI-SERBATOI SU MISURA

I-39030 OBERVINTL / VANDOIES (BZ)
 Tel. +39 0472 868140
 Fax +39 0472 868130
 e-mail: info@tyrolplast.it

WASSERZÄHLER "MADDALENA" TROCKENLÄUFER CDS8 CL. B
CONTATORI "MADDALENA" A TURBINA A GETTO UNICO A QUADRANTE ASCIUTTO CDS8 CL. B

Art. cod.	NW DN	QN m ³ /h	MOD.	TEMP. °C	Länge/lunghezza mm	PREIS/PREZZO	
CDS83.06UZ	1/2"	1,5	CD SD8	30	110	27,00	
CDS85.06XX	3/4"	2,5	CD SD8	30	130	35,00	
CDS83.06YC	1/2"	1,5	CD SD8	90	110	35,00	
CDS85.08QK	3/4"	2,5	CD SD8	90	130	45,30	
AUFPREIS VORBEREITUNG IMPULSGEBER REED-SWITCH						SOVRAPPREZZO PER PREDISPOSIZIONE LANCIAMPULSI REED-SWITCH	3,50
AUFPREIS FÜR SENDER IMPULSE REED-SWITCH						SOVRAPPREZZO PER EMETTITORE DI IMPULSI REED-SWITCH	9,50

WASSERZÄHLER "MADDALENA" TROCKENLÄUFER CDS8TOP CL. B
CONTATORI "MADDALENA" A TURBINA A GETTO UNICO A QUADRANTE ASCIUTTO CDS8TOP CL. B

Art. cod.	NW DN	QN m ³ /h	MOD.	TEMP. °C	Länge/lunghezza mm	PREIS/PREZZO	
CDS8TOP3.0A22	1/2"	1,5	CDS8TOP	30	110	27,00	
CDS8TOP5.0A29	3/4"	2,5	CDS8TOP	30	130	35,00	
CDS8TOP3.0A3A	1/2"	1,5	CDS8TOP	90	110	35,00	
CDS8TOP5.0A92	3/4"	2,5	CDS8TOP	90	130	45,30	



TYROLPLAST
ROHRE - ARMATUREN - BEHÄLTERBAU
TUBI-RACCORDI-SERBATOI SU MISURA

I-39030 OBERVINTL / VANDOIES (BZ)
Tel. +39 0472 868140
Fax +39 0472 868130
e-mail: info@tyrolplast.it

KALTWASSERZÄHLER "MADDALENA" TROCKENLÄUFER DSTRP CL. B
CONTATORI "MADDALENA" A TURBINA A GETTO MULTIPLO A RULLI PROTETTI DSTRP CL. B

Art. cod.	NW DN	QN m ³ /h	MOD.	TEMP. °C	Länge/lunghezza mm	PREIS/PREZZO		
DS3.06J1	1/2"	1,5	DS TRP	30	110-130	42,00		
DS3.05QO	1/2"	1,5	DS TRP	30	145-165	41,00		
DS5.05R4	3/4"	2,5	DS TRP	30	190	50,30		
DS7.05ZL	1"	3,5	DS TRP	30	260	84,50		
DS10.09L2	1 1/4"	5	DS TRP	30	260	106,00		
DS20.06OG	1 1/2"	10	DS TRP	30	300	190,00		
DS30.06JQ	2" Fil.	15	DS TRP	30	300	240,50		
DS30.06OF	2" FI.	15	DS TRP	30	300	217,60		
WARMWASSERZÄHLER AUFPREIS						CONTATORI ACQUA CALDA AUMENTO		+ 30%
AUFPREIS VORBEREITUNG IMPULSGEBER REED-SWITCH				SOVRAPPREZZO PER PREDISPOSIZIONE LANCIAMPULSI REED-SWITCH				7,50
AUFPREIS FÜR SENDER IMPULSE REED-SWITCH				SOVRAPPREZZO PER EMETTITORE DI IMPULSI REED-SWITCH				14,80
AUFPREIS FÜR SENDER IMPULSE QuadraPlus				SOVRAPPREZZO PER EMETTITORE DI IMPULSI statico QuadraPlus				52,00

KALTWASSERZÄHLER "MADDALENA" TROCKENLÄUFER DSTRP CL. C
CONTATORI "MADDALENA" A TURBINA A GETTO MULTIPLO A RULLI PROTETTI DSTRP CL. C

Art. cod.	NW DN	QN m ³ /h	MOD.	TEMP. °C	Länge/lunghezza mm	PREIS/PREZZO		
DS3.05RD-05VQ	1/2"	1,5	DS TRP	30	110-130	48,50		
DS3.05S1-05S2	1/2"	1,5	DS TRP	30	145-165	47,20		
DS5.05SK	3/4"	2,5	DS TRP	30	190	57,90		
DS7.09RQ	1"	3,5	DS TRP	30	260	97,00		
DS10.09SR	1 1/4"	5	DS TRP	30	260	121,70		
DS20.060H	1 1/2"	10	DS TRP	30	300	219,00		
DS30.060J	2" Fil.	15	DS TRP	30	300	277,00		
DS30.060I	2" FI.	15	DS TRP	30	300	250,00		
AUFPREIS VORBEREITUNG IMPULSGEBER REED-SWITCH				SOVRAPPREZZO PER PREDISPOSIZIONE LANCIAMPULSI REED-SWITCH				7,50
AUFPREIS FÜR SENDER IMPULSE REED-SWITCH				SOVRAPPREZZO PER EMETTITORE DI IMPULSI REED-SWITCH				14,80
AUFPREIS FÜR SENDER IMPULSE QuadraPlus				SOVRAPPREZZO PER EMETTITORE DI IMPULSI statico QuadraPlus				52,00

KALTWASSERZÄHLER "MADDALENA" "SUPER DRY" DSSD CL. B
CONTATORI "MADDALENA" A TURBINA A GETTO MULTIPLO "SUPER DRY" DSSD CL. B

Art. cod.	NW DN	QN m ³ /h	MOD.	TEMP. °C	Länge/lunghezza mm	PREIS/PREZZO	
DSSD3.07YH-0797	1/2"	1,5	DSSD	30	145-165	41,00	
DSSD5.0798	3/4"	2,5	DSSD	30	190	50,30	
DSSD7.046V	1"	3,5	DSSD	30	260	84,50	
DSSD10.05BJ	1 1/4"	5,0	DSSD	30	260	106,00	
1.DSSD20.0001	1 1/2"	10,0	DSSD	30	300	190,00	
1.DSSD30.0001	2" Fil.	15,0	DSSD	30	300	240,50	
1.DSSD30.0002	2" FI.	15,0	DSSD	30	300	217,60	

KALTWASSERZÄHLER "MADDALENA" TROCKENLÄUFER VERTIKAL DSTRP R100
CONTATORI "MADDALENA" A TURBINA A GETTO MULTIPLO A RULLI PROTETTI VERTICALE DSTRP R100

Art. cod.	NW DN	QN m ³ /h	MOD.	TEMP. °C	Länge/lunghezza mm	PREIS/PREZZO		
DS3.0D6J	1/2"	2,5	DSTRP	30	105	47,00		
DS5.0D6K	3/4"	4,0	DSTRP	30	105	50,00		
AUFPREIS VORBEREITUNG IMPULSGEBER REED-SWITCH				SOVRAPPREZZO PER PREDISPOSIZIONE LANCIAMPULSI REED-SWITCH				7,40
AUFPREIS FÜR SENDER IMPULSE REED-SWITCH				SOVRAPPREZZO PER EMETTITORE DI IMPULSI REED-SWITCH				14,80



TYROLPLAST
ROHRE - ARMATUREN - BEHÄLTERBAU
TUBI-RACCORDI-SERBATOI SU MISURA

I-39030 OBERVINTL / VANDOIES (BZ)
Tel. +39 0472 868140
Fax +39 0472 868130
e-mail: info@tyrolplast.it

KALTWASSERZÄHLER "MADDALENA" WOLTMANN WMAP VORBEREITET CONTATORI "MADDALENA" A MULINELLO WOLTMANN WMAP PREDISPOSTI							
Art. cod.	NW DN	QN m ³ /h	MOD.	TEMP. °C	Länge/lunghezza mm	PREIS/PREZZO	
1.WHZN50.0001	50	25	WMAP	30	200	307,00	
1.WHZN65.0001	65	40	WMAP	30	200	345,00	
1.WHZN80.0002	80	100	WMAP	30	225	407,00	
1.WHZN100.0001	100	125	WMAP	30	250	544,00	
1.WHZN125.0001	125	125	WMAP	30	250	644,00	
1.WHZN150.0001	150	225	WMAP	30	300	806,60	
1.WHZN200.0001	200	325	WMAP	30	350	962,00	
WARMWASSERZÄHLER AUFPREIS						CONTATORI ACQUA CALDA AUMENTO	+ 30%
AUFPREIS FÜR IMPULSGEBER REED-SWITCH			SOVRAPPREZZO PER EMETTITORE DI IMPULSI REED-SWITCH			38,00	



KALTWASSERZÄHLER "MADDALENA" WOLTMANN HORIZONTAL WP VORBEREITET CONTATORI "MADDALENA" A MULINELLO WOLTMANN ORIZZONTALI WP PREDISPOSTI							
Art. cod.	NW DN	QN m ³ /h	MOD.	TEMP. °C	Länge/lunghezza mm	PREIS/PREZZO	PN 25/40
1.WHHY50.0003	50	30	WP	30	200	447,00	666,00
1.WHHY65.0003	65	50	WP	30	200	510,60	793,00
1.WHHY80.0004	80	120	WP	30	225 (200)	607,50	907,00
1.WHHY100.0002	100	230	WP	30	250	800,00	1.180,00
1.WHHY125.0002	125	250	WP	30	250	960,00	
1.WHHY150.0002	150	250	WP	30	300	1.216,00	2.400,00
1.WHHY200.0004	200	325	WP	30	350	1.443,00	2.860,00
1.WHHY250.0002	250	600	WP	30	450	1.958,00	3.359,00
1.WHHY300.0002	300	700	WP	30	500	5.106,00	6.527,00
1.WHHY400.0002	400	1.250	WP	30	500	7.366,00	9.432,00
1.WHHY500.0002	500	2.000	WP	30	500	8.813,00	11.009,00
WARMWASSERZÄHLER AUFPREIS						CONTATORI ACQUA CALDA AUMENTO	+ 30%
AUFPREIS FÜR IMPULSGEBER REED-SWITCH			SOVRAPPREZZO PER EMETTITORE DI IMPULSI REED-SWITCH			38,00	
AUFPREIS FÜR SENDER IMPULSE OPTISCH + VERSTÄRKER			SOVRAPPREZZO PER EMETTITORE DI IMPULSI OTTICO + AMPLIFICATORE			368,00	







TYROLPLAST
ROHRE - ARMATUREN - BEHÄLTERBAU
TUBI-RACCORDI-SERBATOI SU MISURA

I-39030 OBERVINTL / VANDOIES (BZ)
Tel. +39 0472 868140
Fax +39 0472 868130
e-mail: info@tyrolplast.it

KALTWASSERZÄHLER "MADDALENA" WOLTMANN VERTIKAL WS VORBEREITET
CONTATORI "MADDALENA" A MULINELLO WOLTMANN VERTICALI WS PREDISPOSTI

Art. cod.	NW DN	QN m ³ /h	MOD.	TEMP. °C	Länge/lunghezza mm	PREIS/PREZZO	
1.WVHY50.0002	50	25	WS	30	300 (270)	524,80	
1.WVHY65.0001	65	25	WS	30	300	595,00	
1.WVHY80.0002	80	55	WS	30	350 (300)	632,00	
1.WVHY100.0002	100	90	WS	30	350 (360)	759,00	
1.WVHY150.0001	150	200	WS	30	500 (430)	2.365,00	
AUFPREIS FÜR IMPULSGEBER REED-SWITCH				SOVRAPPREZZO PER EMETTITORE DI IMPULSI REED-SWITCH			38,00
AUFPREIS FÜR SENDER IMPULSE OPTISCH + VERSTÄRKER				SOVRAPPREZZO PER EMETTITORE DI IMPULSI OTTICO + AMPLIFICATORE			368,00

KALTWASSERZÄHLER "MADDALENA" WOLTMANN WPV VORBEREITET
CONTATORI "MADDALENA" A MULINELLO WOLTMANN COMBINATI WPV PREDISPOSTI

Art. cod.	NW DN	QN m ³ /h	MOD.	TEMP. °C	Länge/lunghezza mm	PREIS/PREZZO	
1.WCHY50.0001	50	35	WPV	30	270	1.676,00	
1.WCHY65.0005	65	120	WPV	30	300	1.760,00	
1.WCHY80.0009	80	120	WPV	30	300	1.876,00	
1.WCHY100.0001	100	230	WPV	30	350 (360)	2.486,00	
1.WCHY150.0001	150	425	WPV	30	500	4.092,00	
AUFPREIS FÜR IMPULSGEBER REED-SWITCH				SOVRAPPREZZO PER EMETTITORE DI IMPULSI REED-SWITCH			38,00+38,00
AUFPREIS FÜR SENDER IMPULSE OPTISCH + VERSTÄRKER				SOVRAPPREZZO PER EMETTITORE DI IMPULSI OTTICO + AMPLIFICATORE			368,00+368,00

ELEKTROMAGNETISCHE WASSERZÄHLER "MADDALENA" MODELL 335/LF600
MISURATORI DI PORTATA ELETTROMAGNETICI MODELLO 335/LF600

Art. cod.	NW DN	WAFER		GEFLANSCHT FLANGIATO		
		GUMMI / GOMMA	TEFLON	GUMMI / GOMMA	TEFLON	
	15		1.994,20		2.012,40	
	25		2.048,60		2.100,80	
	40		2.082,60		2.160,60	
	50		2.142,40		2.225,60	
	80	2.288,00		2.350,40		
	100	2.441,40		2.610,40		
	150	2.844,40		3.078,40		
	200			3.837,60		
	250			4.310,80		
	300			5.103,80		
	350			6.076,20		
	400			6.926,40		
AUFPREISE SOVRAPPREZZI						
separate Version versione separata						224,00
24 V alimentazione 24 V						138,00
Ausführung IP 68 protezione IP 68						78,00
separate Version - Kabel/lfm esec. separata - cavo al metro						10,40



TYROLPLAST
ROHRE - ARMATUREN - BEHÄLTERBAU
TUBI-RACCORDI-SERBATOI SU MISURA

I-39030 OBERVINTL / VANDOIES (BZ)
Tel. +39 0472 868140
Fax +39 0472 868130
e-mail: info@tyrolplast.it

		FLACHFLANSCH FLANGE PIANE		FLANSCH MIT SCHWEISSBORD FLANGE A COLLARINO			GEWINDE- FLANSCH FLANGE FILETTATE	GEWINDE- FLANSCH FLANGE FILETTATE	BLIND- FLANSCH FLANGE CIECHE
									
NW / DN		UNI 2277/78 PN 10/16	UNI 6083/84 PN 25/40	UNI 2281/82 PN 10/16	UNI 2283 PN 25	UNI 2284 PN 40	Nach EN 1092-2 50-150 PN16 200-300 PN10	UNI 2254 PN 16	UNI6093 PN 16
		Preis/prezzo	Preis/prezzo	Preis/prezzo	Preis/prezzo	Preis/prezzo	Preis/prezzo	Preis/prezzo	Preis/prezzo
1/2"	15	4,01	3,78	4,26		4,01		4,11	
3/4"	20	4,37	4,11	5,94		5,58		4,68	
1"	25	6,64	4,37	7,12		6,71		5,55	
1 1/4"	32	7,05	6,63	10,37		9,77		7,71	
1 1/2"	40	6,63	7,56	11,97		11,28		8,45	
2"	50	7,98	8,78	11,55		12,59	24,66	11,54	9,23
2 1/2"	65	10,20	11,25	14,16		16,25	29,49	14,34	11,43
3"	80	11,09	13,86	17,24		20,64	30,09	16,95	14,12
4"	100	13,59	19,53	19,55		27,83	33,80	19,70	17,28
5"	125	16,76	26,04	26,66		38,42	42,90		25,08
6"	150	22,28	33,29	33,10		50,34	58,95		32,36
8"	200	30,51	58,59	46,16	70,62	87,74			50,39
10"	250	44,82	96,23	68,15	98,19	143,31	epoxy - pulver- beschichtet		77,93
14"	300	60,18	146,31	91,50	128,90	203,28			110,03
	350								
	400	120,50		172,56					
	450			213,68			verniciate con polvere epossidiche		
	500	210,00		288,23					
	600		651,12	399,42					

VERZ. MUTTERSCHRAUBEN / BULLONI ZINC.

	mm	Preis/prezzo	mm	Preis/prezzo	mm	Preis/prezzo	mm	Preis/prezzo
	14x50	0,65	18x60	1,32	20x80	1,58	22x120	3,27
14x60	0,65	18x70	1,41	20x90	1,71	24x120	3,44	
16x60	0,77	18x80	1,52	20x100	1,88	24x140	4,11	
16x70	0,84	18x90	1,67	20x120	2,16	30x120	6,32	
16x80	0,92	18x100	1,82	22x60	2,28	30x130	6,56	
16x90	0,99	18x120	2,10	22x70	2,33			
16x100	1,10	20x60	1,37	22x90	2,55			
16x120	1,28	20x70	1,47	22x100	2,75			

BEILAGSCHEIBEN VERZINKT / RONDELLE ZINCATE

	mm	Preis/prezzo	mm	Preis/prezzo	mm	Preis/prezzo	mm	Preis/prezzo
	M10	0,05	M16	0,08	M22	0,14	M30	0,35
M12	0,05	M18	0,11	M24	0,21	M33	0,53	
M14	0,06	M20	0,12	M27	0,27	M36	0,60	



TYROLPLAST
ROHRE - ARMATUREN - BEHÄLTERBAU
TUBI-RACCORDI-SERBATOI SU MISURA

I-39030 OBERVINTL / VANDOIES (BZ)
Tel. +39 0472 868140
Fax +39 0472 868130
e-mail: info@tyrolplast.it

LOSFLANSCHEN FÜR VORBUND-SCHWEISSFLANSCH				FLANGE PER CARTELLE				
D PE d PE	D Stahl d acciaio	Stahl PP beschichtet acciaio rivestita PP cod.20.49		ALUMINIUM / ALLUMINIO cod. 20.40		STAHL / ACCIAIO cod. 20.45		
		PN10	PN16	PN10	PN16	PN10	PN16	PN25
40	32		11,34		9,30			
50	40		12,75		9,69		13,23	
63	50		15,84		10,74		15,96	
75	65		18,30		14,37		19,41	36,24
90	80		20,61		16,44		21,03	45,30
110	100		23,25		18,24		25,77	59,28
125	100		23,25		18,51		26,55	59,28
140	125		33,09		22,86		30,69	79,89
160	150		41,76		26,73		43,68	100,47
180	150		45,69		26,73		45,93	
200	200	60,96	77,49	37,35	55,77	55,77		
225	200	60,96	77,49	37,35	55,77	58,02		
250	250	88,56	96,18	49,41	70,38	84,51		
280	250	88,56	96,19	49,41	77,64	86,40		
315	300	130,29	157,71	58,50	83,37	114,21		

DICHTUNGEN GUARNIZIONI								
AUS LEINWANDGUMMI 3 mm DI GOMMA 3 mm		AUS KLINGERIT ASBESTFREI DI KLINGERIT SENZA AMIANTO		KLINGER GUMMI-STAHL KLINGER ANIMA IN ACCIAIO		KTR		
NW DN	PN16	NW DN	PN16/40	NW DN	PN10	PN16	PN25/40	PN64
						PN 16/40 *	PN 16/40 *	
40				40		4,32*		
50	2,11	50	2,63	50		4,65 *		
65	2,37	65	3,33	65		4,80 *		
80	2,65	80	3,68	80		4,97 *		
100	3,04	100	4,34	100		5,67	5,84	
125	3,80	125	6,70	125		6,48	7,50	
150	4,59	150	7,54	150		7,94	8,43	
200	5,64	200	12,39	200		10,16	10,20	
250	8,22	250	16,76	250	10,26	10,26	10,37	
300	12,17	300	36,87	300	15,99	16,85	17,45	
350		350		350	19,77	20,19	20,52	
400		400	102,65	400	21,93	22,47	22,89	
450		450	109,88	450		33,48		
500		500	153,75	500	38,01	38,34	39,63	
600		600	159,68	600	43,74	45,03	45,36	
700				700	61,23	73,11	85,43	
800				800	101,52	106,92	113,94	
900				900	112,86	123,12	124,20	
1000				1000	119,88	149,04	164,16	
1200				1200	334,80	334,18	360,72	

AUF ANFRAGE
SU RICHIESTA

INOX MUTTERSCHRAUBEN / BULLONI INOX								
	mm	Preis / prezzo	mm	Preis / prezzo	mm	Preis / prezzo	mm	Preis / prezzo
	14x50	1,61	16x70	2,07	18x80	3,83	22x90	9,18
	14x60	1,71	16x80	2,27	18x100	4,43		
	16x60	1,88	16x90	2,60	24x120	10,98		





TYROLPLAST
ROHRE - ARMATUREN - BEHÄLTERBAU
TUBI-RACCORDI-SERBATOI SU MISURA

I-39030 OBERVINTL / VANDOIES (BZ)
Tel. +39 0472 868140
Fax +39 0472 868130
e-mail: info@tyrolplast.it

Art. 6583.00		KUGELVENTIL VALVOLA A SFERA								
	1/2"	3/4"	1"	1 1/4"	1 1/2"	2"	2 1/2"	3"	4"	
	PN16	PN16	PN16	PN16	PN16	PN16	PN16	PN16		
	6,87	9,92	14,40	22,37	34,37	50,18	101,46	169,11		

Art. 1167.55		ABSPERRVENTIL mit Rückflusssperre und bergseit. Entleerung RUBINETTO D'ARRESTO UNIDIREZIONALE con rubinetto di sc. a monte								
	1/2"	3/4"	1"	1 1/4"	1 1/2"	2"				
	PN16	PN16	PN16	PN16	PN16	PN16				
	34,11	42,26	62,01	117,47	135,86	197,87				



Art. 6543.45		KUGELVENTIL MIT PE-ANSCHLUSS VALVOLA A SFERA CON ATT. PE								
	1/2"	3/4"	1"	1 1/4"	1 1/2"	2"				
PN16	13,10	17,46	24,56	38,19	55,64	96,00				

Art. 1140.00		SCHRÄGSITZVENTIL IN BRONZE VALVOLA INCLINATA IN BRONZO								
	1/2"	3/4"	1"	1 1/4"	1 1/2"	2"	2 1/2"	3"	4"	
	23,31	29,97	35,90	53,18	64,49	110,25	160,77	229,64	401,55	

Art. 1105.00		BRONZESCHIEBER SARACINESCA IN BRONZO								
	1/2"	3/4"	1"	1 1/4"	1 1/2"	2"	2 1/2"	3"	4"	
PN25	24,69	30,08	35,72	44,22	61,67	105,18	147,05	204,75	355,20	

Art. 6570.00		KUGELAUSLAUFHAHN MIT SCHLAUCHANSCHLUSS RUBINETTO CURVO A SFERA CON PORTAGOMMA								
	3/8"	1/2"	3/4"	1"						
PN16	10,92	10,92	16,08	18,95						

	AB- UND ÜBERLAUFGARNITUREN IN MESSING TURI CONICI IN OTTONE PER TROPPO PIENO								
	5/4"	6/4"	50-2"	70-2 1/2"	80-3"	100-4"	125-5"	150-6"	
	23,90	31,52	77,49	79,65	106,11	183,60	306,05	422,42	

GÜLLESCHIEBER SARACINESCA A STANTUFFO						
NW DN		100-4"	125-5"	150-6"	Art.10	Art.40
Art. 10		231,42	281,03	284,56		
Art. 40		195,42	250,21	267,76		



TYROLPLAST
 ROHRE - ARMATUREN - BEHÄLTERBAU
 TUBI-RACCORDI-SERBATOI SU MISURA

I-39030 OBERVINTL / VANDOIES (BZ)
 Tel. +39 0472 868140
 Fax +39 0472 868130
 e-mail: info@tyrolplast.it

**ABMESSUNGEN UND GEWICHTE DER VENTILE
 DIMENSIONI E PESI DELLE VALVOLE**



DN	FLANSCHEN - FLANGE			S	H	L	kg
	PN10	PN16	PN25				
50	165	165	165	230	220	170	18
65	185	185	185	290	250	180	26
80	200	200	200	310	280	200	32
100	220	220	235	350	310	210	45
125	250	250	270	350	380	230	69
150	285	285	300	480	420	250	98
200	340	340	360	600	520	280	150
250	395	405	425	730	600	300	230
300	445	460	485	850	740	340	380
400	565	580	620	1100	810	390	550
500	670	715	730	1250	890	460	860
600	780	840	845	1450	970	540	1100
700	895	910		1650	1020	590	1450
800	1015	1025		1850	1070		1900

**RICHTLINIE ZUM EINBAU VON REGELVENTILEN
 RACCOMANDAZIONI PER UN CORRETTO
 MONTAGGIO DELLE VALVOLE DI REGOLAZIONE**

1	Regelventil Valvola di regolazione	7	Mauerflansch Flangia di ancoraggio
2	Schmutzfänger Racc. impurità	10	Regelventil Valvola di regolazione
3	Be- u. Entlüftungsventil Sfalo a tre funzioni	11	Schmutzfänger Filtro con rubinetto di spurgo
4	Absperrschieber Organo di intercettazione	12	Sicherheitsventil Valvola di sicurezza
5	Ausbaustück Giunto di montaggio	13A	Absperrschieber Vordruck (geschl.) Organo di interc. a monte (chiuso)
6	Flanschenübergangsstück Riduzione flangiata	13B	Absperrschieber (offen) Organo di interc. a valle (aperto)

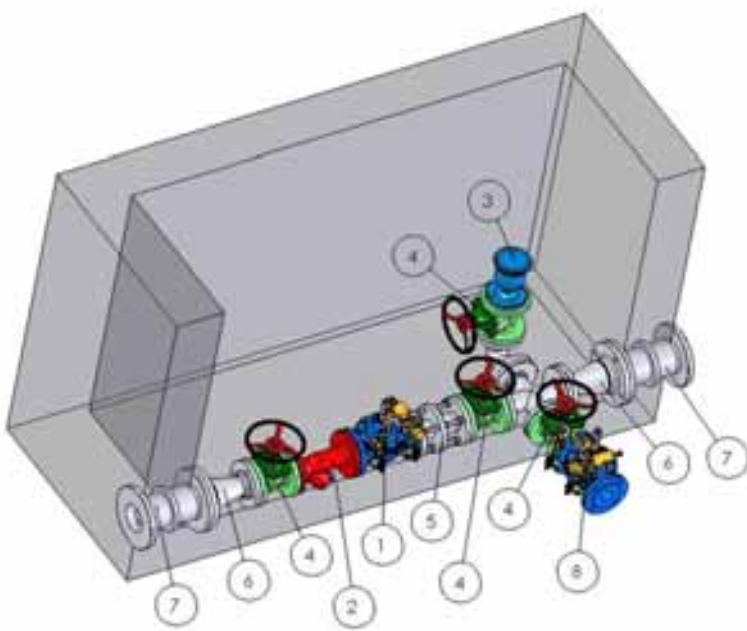
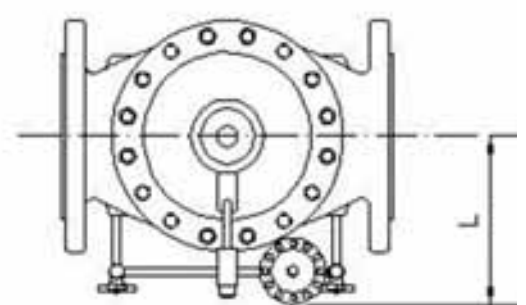
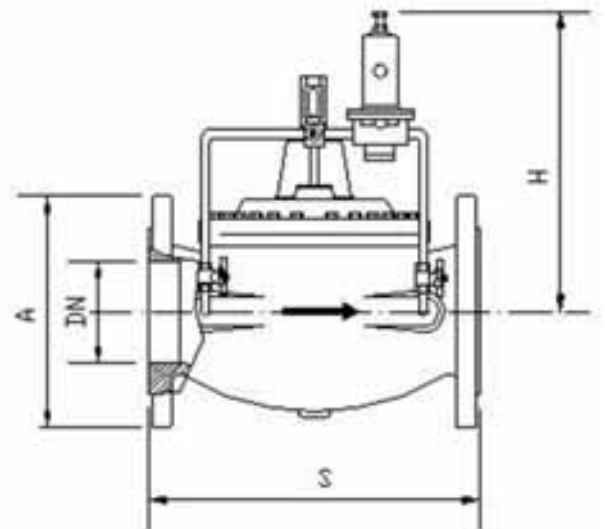



TYROLPLAST
ROHRE - ARMATUREN - BEHÄLTERBAU
TUBI-RACCORDI-SERBATOI SU MISURA

I-39030 OBERVINTL / VANDOIES (BZ)
Tel. +39 0472 868140
Fax +39 0472 868130
e-mail: info@tyrolplast.it

DRUCKREDUZIERVERTILE
VALVOLE RIDUTTRICI DI PRESSIONE



NUOVAL-TYROLPLAST

HYDRAULISCHES DRUCKREDUZIERVERTIL
VALVOLA RIDUTTRICE E STABILIZZATRICE DI
PRESSIONE



	Mod. M3100016 NUOVAL-TYROLPLAST	Mod. M2100025 NUOVAL-TYROLPLAST
DN	PN 10-16	PN 25
50	1.259,00	1.259,00
65	1.398,00	1.398,00
80	1.431,00	1.590,00
100	1.526,00	1.973,00
125	2.183,00	2.276,00
150	2.456,00	3.753,00
200	3.817,00	5.310,00
250	6.811,00	7.241,00
300	9.025,00	9.534,00
400	16.136,00	16.136,00
500	24.910,00	24.910,00
600	32.411,00	32.411,00
700	43.294,00	44.058,00
800	49.218,00	

HYDRAULISCHES DRUCKREDUZIER- UND
DRUCKHALTEVENTIL
VALVOLA RIDUTTRICE E SOSTEGNO DI
PRESSIONE

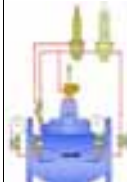

	Mod. M3120016 NUOVAL-TYROLPLAST	Mod. M2120025 NUOVAL-TYROLPLAST
DN	PN 10-16	PN 25
50	1.599,00	1.599,00
65	1.750,00	1.750,00
80	1.783,00	1.967,00
100	1.868,00	2.315,00
125	2.523,00	2.620,00
150	2.807,00	4.106,00
200	4.170,00	5.662,00
250	7.164,00	7.594,00
300	9.380,00	9.885,00
400	16.498,00	16.498,00
500	25.272,00	25.272,00
600	32.773,00	32.773,00
700	44.420,00	44.420,00
800	49.579,00	

HYDRAULISCHES DRUCKREDUZIERVERTIL MIT
ELEKTRISCHER FERNSTEUERUNG
VALVOLA RIDUTTRICE E STABILIZZATRICE DI
PRESSIONE CON COMANDO ELETTRICO REMOTO



	Mod. M3170016 NUOVAL-TYROLPLAST	Mod. M2170025 NUOVAL-TYROLPLAST
DN	PN 10-16	PN 25
50	2.018,00	2.018,00
65	2.159,00	2.159,00
80	2.192,00	2.346,00
100	2.282,00	2.734,00
125	2.941,00	3.038,00
150	3.226,00	4.525,00
200	4.589,00	6.081,00
250	7.581,00	8.013,00
300	9.797,00	10.304,00
400	16.915,00	16.915,00
500	25.686,00	25.686,00
600	33.190,00	33.190,00
700	44.656,00	45.401,00
800	49.813,00	

Das Ventil ist komplett mit Dreiwegventil für Manometeranschluss
Valvola completa di valvola a 3 vie portamanometro

Sichtglas für Stellungsanzeige mit
Entlüftungshahn extra
Indicatore di posizione visivo e
valvola di sfiato manuale

DN	Preis/prezzo
50-125	75,60
150-300	84,00
400-800	165,90

Manometer/manometro
26,25

Optional:
Range taratura fino a 22 bar
42,00

Optional:
Range taratura fino a 30 bar
63,00

v-port

DN	Preis/prezzo
50	168,00
65	195,30
80	241,50
100	279,30
125	279,30
150	382,20
200	459,90
250	598,50
300	766,50



TYROLPLAST
 ROHRE - ARMATUREN - BEHÄLTERBAU
 TUBI-RACCORDI-SERBATOI SU MISURA

I-39030 OBERVINTL / VANDOIES (BZ)
 Tel. +39 0472 868140
 Fax +39 0472 868130
 e-mail: info@tyrolplast.it

**HYDRAULISCHES DRUCKHALTEVENTIL/SICHERHEITSVENTIL
 VALVOLE SOSTEGNO DELLA PRESSIONE**



**HYDRAULISCHES DRUCKHALTEVENTIL
 SICHERHEITSVENTIL
 VALVOLA DI SOSTEGNO O DI SFIORO DELLA
 PRESSIONE**



Mod. M3200016
 NUOVAL-TYROLPLAST

Mod. M2200025
 NUOVAL-TYROLPLAST

DN	PN 10-16	PN 25
50	1.323,00	1.323,00
65	1.462,00	1.462,00
80	1.495,00	1.654,00
100	1.590,00	2.040,00
125	2.247,00	2.344,00
150	2.520,00	3.817,00
200	3.881,00	5.374,00
250	6.875,00	7.305,00
300	9.089,00	9.598,00
400	16.200,00	16.200,00
500	24.974,00	24.974,00
600	32.475,00	32.475,00
700	44.124,00	44.124,00
800	49.282,00	

Das Ventil ist komplett mit Dreiwegventil für Manometeranschluss
 Valvola completa di valvola a 3 vie portamanometro

Sichtglas für Stellungsanzeige mit
 Entlüftungshahn extra
 Indicatore di posizione visivo e
 valvola di sfiato manuale

DN	Preis/prezzo
50-125	75,60
150-300	84,00
400-800	165,90

Manometer/manometro
 26,25

Optional:
 Range taratura fino a 22 bar
 42,00

Optional:
 Range taratura fino a 30 bar
 63,00

v-port

DN	Preis/prezzo
50	168,00
65	195,30
80	241,50
100	279,30
125	279,30
150	382,20
200	459,90
250	598,50
300	766,50

Mod. A230025 NUOVAL-TYROLPLAST

**HYDRAULISCHES
 SICHERHEITSVENTIL
 (Eckventil)
 VALVOLA DI SOSTEGNO DELLA
 PRESSIONE (squadra)**



DN	PN 25
50	1.299,00





TYROLPLAST
ROHRE - ARMATUREN - BEHÄLTERBAU
TUBI-RACCORDI-SERBATOI SU MISURA

I-39030 OBERVINTL / VANDOIES (BZ)
Tel. +39 0472 868140
Fax +39 0472 868130
e-mail: info@tyrolplast.it

**HYDRAULISCHES DURCHFLUSSMENGEN-KONTROLLVENTIL
VALVOLA LIMITATRICE E CONTROLLO PORTATA**



NUOVAL-TYROLPLAST



HYDRAULISCHES DURCHFLUSSMENGEN-KONTROLLVENTIL VALVOLA LIMITATRICE E CONTROLLO DI PORTATA			HYDR. DURCHFLUSSMENGEN-KONTROLLVENTIL MIT EINGEBAUTER DRUCKREDUZIERSTUFE VALVOLA LIMITATRICE DI PORTATA E RIDUTTRICE E STABILIZZATRICE DI PRESSIONE DI VALLE		
	Mod. M3400016 NUOVAL-TYROLPLAST	Mod. M2400025 NUOVAL-TYROLPLAST		Mod. M3410016 NUOVAL-TYROLPLAST	Mod. M2410025 NUOVAL-TYROLPLAST
DN	PN 10-16	PN 25	DN	PN 10-16	PN 25
50	1.727,00	1.727,00	50	2.004,00	2.004,00
65	1.883,00	1.883,00	65	2.159,00	2.159,00
80	1.916,00	2.089,00	80	2.192,00	2.366,00
100	2.048,00	2.500,00	100	2.328,00	2.776,00
125	2.730,00	2.822,00	125	3.005,00	3.102,00
150	3.034,00	4.333,00	150	3.323,00	4.619,00
200	4.476,00	5.969,00	200	4.765,00	6.258,00
250	7.559,00	7.991,00	250	7.850,00	8.278,00
300	9.883,00	10.388,00	300	10.169,00	10.677,00
400	17.316,00	17.316,00	400	17.611,00	17.611,00
500	26.290,00	26.290,00	500	26.588,00	26.588,00
600	33.953,00	33.953,00	600	34.248,00	34.248,00
700	45.871,00	45.871,00	700	46.166,00	46.166,00
800	51.277,00		800	51.575,00	



TYROLPLAST
ROHRE - ARMATUREN - BEHÄLTERBAU
TUBI-RACCORDI-SERBATOI SU MISURA

I-39030 OBERVINTL / VANDOIES (BZ)
Tel. +39 0472 868140
Fax +39 0472 868130
e-mail: info@tyrolplast.it

**HYDR. SCHWIMMER-REGULIERVENTIL FÜR KONSTANTEN WASSERSTAND
VALVOLA DI REGOLAZIONE "LIVELLO COSTANTE" A GALLEGGIANTE**

HYDRAULISCHES SCHWIMMER-REGULIERVENTIL FÜR KONSTANTEN WASSERSTAND VALVOLA DI REGOLAZIONE "LIVELLO COSTANTE" A GALLEGGIANTE			HYDRAULISCHES DURCHFLUSSMENGENREGULIER- DRUCKHALTE VENTIL VALVOLA LIMITATRICE DI PORTATA, RIDUTTRICE E STABILIZZATRICE DI PRESSIONE DI VALLE		
	Mod. M3500016 NUOVAL-TYROLPLAST	Mod. M2500025 NUOVAL-TYROLPLAST		Mod. M3520016 NUOVAL-TYROLPLAST	Mod. M2520025 NUOVAL- TYROLPLAST
	DN	PN 10-16		PN 25	DN
50	1.568,00	1.568,00	50	1.905,00	1.905,00
65	1.704,00	1.704,00	65	2.046,00	2.046,00
80	1.738,00	1.896,00	80	2.079,00	2.236,00
100	1.832,00	2.280,00	100	2.174,00	2.622,00
125	2.492,00	2.584,00	125	2.829,00	2.926,00
150	2.763,00	4.062,00	150	3.113,00	4.412,00
200	4.126,00	5.618,00	200	4.476,00	5.969,00
250	7.118,00	7.548,00	250	7.473,00	7.901,00
300	9.334,00	9.841,00	300	9.689,00	10.194,00
400	16.443,00	16.443,00	400	16.804,00	16.804,00
500	25.216,00	25.216,00	500	25.578,00	25.578,00
600	32.718,00	32.718,00	600	33.079,00	33.079,00
700	44.365,00	44.365,00	700	44.726,00	45.562,00
800	49.527,00		800	49.886,00	

Das Ventil ist komplett mit Dreiwegventil für Manometeranschluss
Valvola completa di valvola a 3 vie portamanometro

Sichtglas für Stellungsanzeige mit
Entlüftungshahn extra
Indicatore di posizione visivo e
valvola di sfiato manuale

DN	Preis/prezzo
50-125	98,70
150-300	109,20
400-800	218,40

Manometer/manometro
26,25

Optional:
Range taratura fino a 22 bar

Optional:
Range taratura fino a 30 bar

v-port

DN	Preis/prezzo
50	168,00
65	195,30
80	241,50
100	279,30
125	279,30
150	382,20
200	459,90
250	598,50
300	766,50



TYROLPLAST
ROHRE - ARMATUREN - BEHÄLTERBAU
TUBI-RACCORDI-SERBATOI SU MISURA

I-39030 OBERVINTL / VANDOIES (BZ)
Tel. +39 0472 868140
Fax +39 0472 868130
e-mail: info@tyrolplast.it

HYDR. SCHWIMMER-AUF/ZU-VENTIL FÜR VARIABLEN WASSERSTAND
VALVOLA DI CONTROLLO LIV. MIN-MAX A GALLEGGIANTE



HYDRAULISCHES SCHWIMMER-AUF/ZU-VENTIL
FÜR VARIABLEN WASSERSTAND
VALVOLA DI CONTROLLO LIVELLO MIN-MAX A
GALLEGGIANTE

	Mod. M3600016 NUOVAL-TYROLPLAST	Mod. M3260025 NUOVAL-TYROLPLAST
DN	PN 10-16	PN 25
50	1.685,00	1.685,00
65	1.826,00	1.826,00
80	1.859,00	2.015,00
100	1.951,00	2.401,00
125	2.609,00	2.706,00
150	2.884,00	4.183,00
200	4.242,00	5.740,00
250	7.239,00	7.671,00
300	9.455,00	9.960,00
400	16.562,00	16.562,00
500	25.338,00	25.338,00
600	32.839,00	32.839,00
700	44.486,00	44.486,00
800	49.648,00	

HYDRAULISCHES DURCHFLUSSMENGEN-AUF/ZU
NIVEAU-KONTROLLVENTIL
VALVOLA LIMITATRICE DI PORTATA E
CONTROLLO LIVELLO MIN-MAX

	Mod. M3460016 NUOVAL-TYROLPLAST	Mod. M2460025 NUOVAL-TYROLPLAST
DN	PN 10-16	PN 25
50	2.622,00	2.622,00
65	2.776,00	2.776,00
80	2.809,00	2.983,00
100	2.944,00	3.391,00
125	3.623,00	3.718,00
150	3.938,00	5.237,00
200	5.380,00	6.875,00
250	8.467,00	8.895,00
300	10.787,00	11.292,00
400	18.227,00	18.227,00
500	27.205,00	27.205,00
600	34.865,00	34.865,00
700	46.781,00	46.781,00
800	52.192,00	

HYDRAULISCHES SCHWIMMER-AUF/ZU-VENTIL
FÜR VARIABLEN WASSERSTAND UND
DRUCKHALTEVENTIL
VALVOLA CONTROLLO LIVELLO MAX-MIN A
GALLEGGIANTE E SOSTEGNO DELLA PRESSIONE A
MONTE

	Mod. M3620016 NUOVAL-TYROLPLAST	Mod. M2620025 NUOVAL-TYROLPLAST
DN	PN 10-16	PN 25
50	2.216,00	2.216,00
65	2.357,00	2.357,00
80	2.390,00	2.545,00
100	2.485,00	2.933,00
125	3.142,00	3.235,00
150	3.424,00	4.723,00
200	4.787,00	6.280,00
250	7.781,00	8.211,00
300	9.997,00	10.502,00
400	17.115,00	17.115,00
500	25.889,00	25.889,00
600	33.388,00	33.388,00
700	45.037,00	45.037,00
800	50.197,00	

Das Ventil ist komplett mit Dreiwegventil für Manometeranschluss
Valvola completa di valvola a 3 vie portamanometro

Sichtglas für Stellungsanzeige mit
Entlüftungshahn extra
Indicatore di posizione visivo e
valvola di sfiato manuale

DN	Preis/prezzo
50-125	75,60
150-300	84,00
400-800	165,90

Manometer/manometro
26,25

Optional:
Range taratura fino a 22 bar

Optional:
Range taratura fino a 30 bar

v-port

DN	Preis/prezzo
50	168,00
65	195,30
80	241,50
100	279,30
125	279,30
150	382,20
200	459,90
250	598,50
300	766,50



TYROLPLAST
ROHRE - ARMATUREN - BEHÄLTERBAU
TUBI-RACCORDI-SERBATOI SU MISURA

I-39030 OBERVINTL / VANDOIES (BZ)
Tel. +39 0472 868140
Fax +39 0472 868130
e-mail: info@tyrolplast.it

HYDR. ROHRBRUCHSICHERUNGSVENTIL VALVOLA ECCESSO DI PORTATA



HYDRAULISCHES ROHRBRUCHSICHERUNGSVENTIL VALVOLA DI SEZIONAMENTO PER ECCESSO DI PORTATA



Mod. M3900016
NUOVAL-TYROLPLAST

Mod. M29000025
NUOVAL-TYROLPLAST

Das Ventil ist komplett mit Dreiwegventil für Manometeranschluss
Valvola completa di valvola a 3 vie portamanometro

Sichtglas für Stellungsanzeige mit
Entlüftungshahn extra
Indicatore di posizione visivo e
valvola di sfiato manuale

DN	PN 10-16	PN 25
50	2.765,00	2.765,00
65	2.919,00	2.919,00
80	2.952,00	3.127,00
100	3.089,00	3.539,00
125	3.771,00	3.863,00
150	4.073,00	5.369,00
200	5.515,00	7.007,00
250	8.597,00	9.029,00
300	10.921,00	11.426,00
400	18.354,00	18.354,00
500	27.331,00	27.331,00
600	35.024,00	35.024,00
700	46.909,00	46.909,00
800	52.316,00	

DN	Preis/prezzo
50-125	75,60
150-300	84,00
400-800	165,90

Manometer/manometro
26,25

Optional:
Range taratura fino a 22 bar

Optional:
Range taratura fino a 30 bar

HYDR. SCHWIMMERLOSES-NIVEAU-AUF/ZU-VENTIL FÜR VAR. WASSERSTAND VALVOLA DI SEZIONAMENTO PIEZOMETRICA



HYDRAULISCHES SCHWIMMERLOSES-NIVEAU- AUF/ZU-VENTIL FÜR VARIABLEN WASSERSTAND VALVOLA DI SEZIONAMENTO PIEZOMETRICA UNIDIREZIONALE



Mod. M3800016
NUOVAL-TYROLPLAST

Mod. M28000025
NUOVAL-TYROLPLAST

Das Ventil ist komplett mit Dreiwegventil für Manometeranschluss
Valvola completa di valvola a 3 vie portamanometro

Sichtglas für Stellungsanzeige mit
Entlüftungshahn extra
Indicatore di posizione visivo e
valvola di sfiato manuale

DN	PN 10-16	PN 25
50	2.858,00	2.858,00
65	2.997,00	2.997,00
80	3.030,00	3.188,00
100	3.124,00	3.574,00
125	3.782,00	3.879,00
150	3.965,00	5.263,00
200	5.327,00	6.820,00
250	8.322,00	8.752,00
300	10.538,00	11.043,00
400	17.651,00	17.651,00
500	26.425,00	26.425,00
600	33.895,00	33.895,00
700	45.577,00	45.577,00
800	50.737,00	

DN	Preis/prezzo
50-125	75,60
150-300	84,00
400-800	165,90

Manometer/manometro
26,25

Optional:
Range taratura fino a 22 bar

Optional:
Range taratura fino a 30 bar



TYROLPLAST
ROHRE - ARMATUREN - BEHÄLTERBAU
TUBI-RACCORDI-SERBATOI SU MISURA

I-39030 OBERVINTL / VANDOIES (BZ)
Tel. +39 0472 868140
Fax +39 0472 868130
e-mail: info@tyrolplast.it

HYDRAULISCHES DRUCKREDUZIERVENTIL SERIE P
VALVOLE A PISTONE SERIE P



NUOVAL-TYROLPLAST

Mod. P2100P16 Mod. P2100P25 Mod. P2100P40

Mod. P210016 Mod. P210025 Mod. P210040

**HYDRAULISCHES
DRUCKREDUZIERVENTIL**

**VALVOLA RIDUTTRICE E
STABILIZZATRICE DI
PRESSIONE PROPORZ.**



**HYDRAULISCHES
DRUCKREDUZIERVENTIL**

**VALVOLA RIDUTTRICE E
STABILIZZATRICE DI
PRESSIONE**



DN	PN 10-16	PN 25	PN 40
50	1.462,00	1.462,00	1.865,00
65	1.777,00	1.777,00	2.284,00
80	2.145,00	2.145,00	2.758,00
100	2.752,00	2.785,00	3.603,00
125	2.983,00	3.069,00	4.086,00
150	5.557,00	5.647,00	7.232,00
200	8.547,00	8.705,00	
250	11.839,00	12.478,00	
300	15.891,00	16.979,00	

DN	PN 10-16	PN 25	PN 40
50	1.696,00	1.696,00	2.198,00
65	2.011,00	2.011,00	2.615,00
80	2.379,00	2.379,00	3.089,00
100	2.986,00	3.019,00	3.934,00
125	3.213,00	3.303,00	4.417,00
150	5.817,00	5.905,00	7.594,00
200	8.805,00	8.966,00	
250	12.099,00	12.738,00	
300	16.149,00	17.236,00	

Mod. P21200P16 Mod. P21200P25 Mod. P21200P40

Mod. P2200016 Mod. P2200025 Mod. P2200040

**HYDRAULISCHES
DRUCKREDUZIER- UND
DRUCKHALTEVENTIL**

**VALVOLA RIDUTTRICE E
SOSTEGNO DI PRESSIONE**



**HYDRAULISCHES
DRUCKHALTE-
SICHERHEITVENTIL**

**VALVOLA DI SOSTEGNO E DI
SFIORO DELLA PRESSIONE**



DN	PN 10-16	PN 25	PN 40
50	2.037,00	2.037,00	2.586,00
65	2.353,00	2.353,00	3.001,00
80	2.721,00	2.721,00	3.477,00
100	3.327,00	3.360,00	4.322,00
125	3.554,00	3.645,00	4.802,00
150	6.172,00	6.258,00	7.993,00
200	9.157,00	9.316,00	
250	12.449,00	13.089,00	
300	16.500,00	17.591,00	

DN	PN 10-16	PN 25	PN 40
50	1.760,00	1.760,00	2.284,00
65	2.075,00	2.075,00	2.703,00
80	2.443,00	2.443,00	3.175,00
100	3.050,00	3.083,00	4.020,00
125	3.281,00	3.367,00	4.505,00
150	5.883,00	5.969,00	7.680,00
200	8.869,00	9.029,00	
250	12.163,00	12.802,00	
300	16.213,00	17.303,00	



TYROLPLAST
 ROHRE - ARMATUREN - BEHÄLTERBAU
 TUBI-RACCORDI-SERBATOI SU MISURA

I-39030 OBERVINTL / VANDOIES (BZ)
 Tel. +39 0472 868140
 Fax +39 0472 868130
 e-mail: info@tyrolplast.it

**HYDRAULISCHES DRUCKREDUZIERVENTIL SERIE P
 VALVOLE A PISTONE SERIE P**

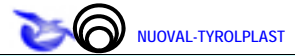

Mod. P2400016 Mod. P2400025 Mod. P2400040

Mod. P2500016 Mod. P2500025 Mod. P2500040

**HYDRAULISCHES
 DURCHFLUSSMENGEN-
 KONTROLLVENTIL**



**VALVOLA LIMITATRICE E
 CONTROLLO DI PORTATA**

**HYDRAULISCHES
 SCHWIMMER-
 REGULIERVENTIL FÜR
 KONSTANTEN WASSERSTAND**



**VALVOLA DI REGOLAZIONE
 "LIVELLO COSTANTE" A
 GALLEGGIANTE**

DN	PN 10-16	PN 25	PN 40
50	2.165,00	2.165,00	auf Anfrage a richiesta
65	2.496,00	2.496,00	
80	2.880,00	2.880,00	
100	3.515,00	3.543,00	
125	3.764,00	3.850,00	
150	6.395,00	6.485,00	
200	9.384,00	9.541,00	
250	12.674,00	13.314,00	
300	16.725,00	17.814,00	

DN	PN 10-16	PN 25	PN 40
50	2.200,00	2.200,00	auf Anfrage a richiesta
65	2.318,00	2.318,00	
80	2.686,00	2.686,00	
100	3.295,00	3.226,00	
125	3.520,00	3.610,00	
150	6.124,00	6.212,00	
200	9.114,00	9.273,00	
250	12.406,00	13.045,00	
300	16.456,00	17.543,00	

ROHRBRUCHSICHERUNGSKLAPPE



VALVOLA A FARFALLA DI SICUREZZA PER ECCESSO DI VELOCITA'

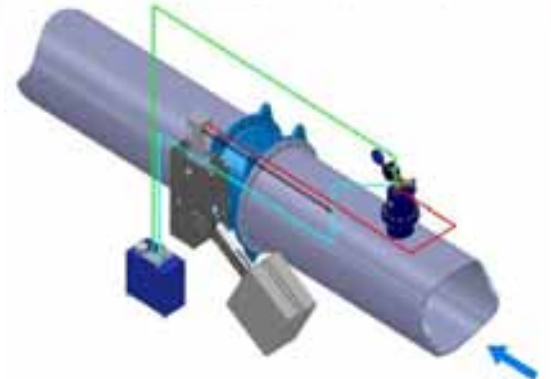
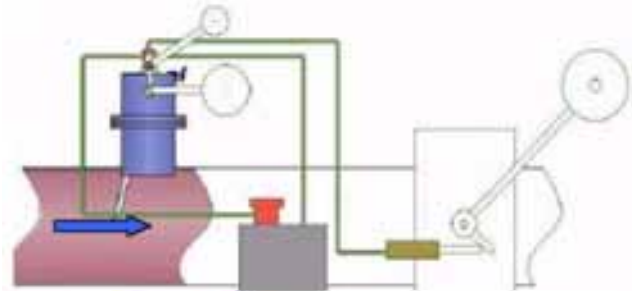
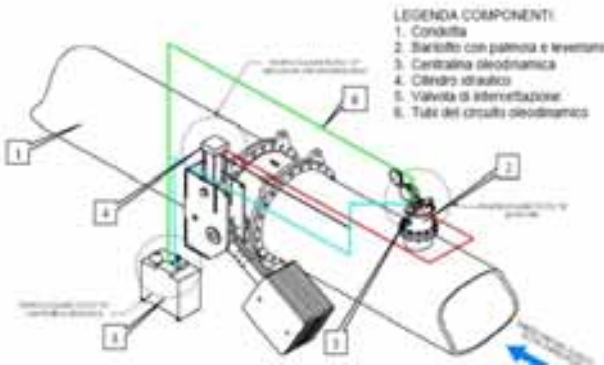

DN				
80				
100				
125				
150	AUF ANFRAGE / A RICHIESTA			
200				
250				
300				
400				



TYROLPLAST
ROHRE - ARMATUREN - BEHÄLTERBAU
TUBI-RACCORDI-SERBATOI SU MISURA

I-39030 OBERVINTL / VANDOIES (BZ)
Tel. +39 0472 868140
Fax +39 0472 868130
e-mail: info@tyrolplast.it

RINGKOLBENVENTIL PN 16-25-40-64 KOMPLETT MIT RED. AUMA MOD. GS
VALVOLA A FUSO PN 16-25-40-64 COMPLETA DI RIDUTTORE AUMA MOD. GS

Mod. F500 NUOVAL-TYROLPLAST



NUOVAL-TYROLPLAST

Ringkolbenventil in GG 400 Mod. F500 komplett mit Auma Antrieb Mod. GS mit Handrad
Valvola a fuso monocolpo in ghisa GS 400 mod. F500 completa di riduttore Auma mod. GS con volantino o predisposta per attuatore

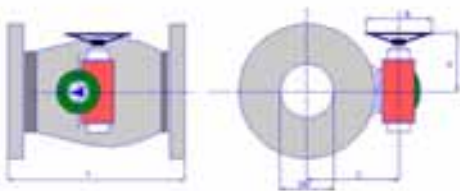

DN	PN 16	PN 25	PN 40	PN 64	LOCHZYLINDER IN INOX AISI 304 OTTURATORE FORATO IN ACC. AISI 304	DN	€
80							80
100					100		A RICHIESTA
125					125		ANFRAGE
150	AUF ANFRAGE / A RICHIESTA				150		A RICHIESTA
200					200		ANFRAGE
250					250		A RICHIESTA
300					300		ANFRAGE
400					400		A RICHIESTA

RINGKOLBENVENTIL PN 16-25-40-64 ohne Antrieb
VALVOLA A FUSO PN 16-25-40-64 senza riduttore



NUOVAL-TYROLPLAST

Mod. F500 NUOVAL-TYROLPLAST

Ringkolbenventil in GG 400 Mod. F500 ohne Antrieb
Valvola a fuso monocolpo in ghisa GS 400 mod. F500 senza riduttore

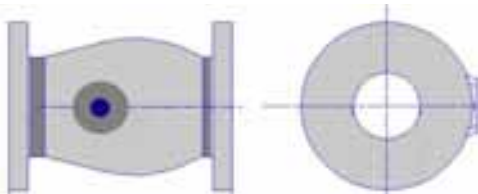

DN	PN 16	PN 25	PN 40	PN 64	LOCHZYLINDER IN INOX AISI 304 OTTURATORE FORATO IN ACC. AISI 304	DN	€
80							80
100					100		A RICHIESTA
125					125		ANFRAGE
150	AUF ANFRAGE / A RICHIESTA				150		A RICHIESTA
200					200		ANFRAGE
250					250		A RICHIESTA
300					300		ANFRAGE
400					400		A RICHIESTA



TYROLPLAST
ROHRE - ARMATUREN - BEHÄLTERBAU
TUBI-RACCORDI-SERBATOI SU MISURA

I-39030 OBERVINTL / VANDIOIES (BZ)
Tel. +39 0472 868140
Fax +39 0472 868130
e-mail: info@tyrolplast.it

MATERIALRETOURNAHME

Aus organisatorischen Gründen bitten wir bei Warenrückgaben - im Interesse einer raschen und korrekten Abwicklung - um *Kenntnisnahme und Einhaltung folgender Bedingungen*:

Retourwaren können nur nach vorheriger Rücksprache und Vereinbarung mit unserer Verkaufsabteilung übernommen werden. Unangemeldet angeliefertes Retourenmaterial wird von uns zurückgewiesen.

Ebenso dürfen unsere Fahrer ohne unseren entsprechenden Auftrag vor Ort kein Retourenmaterial annehmen.

Die Angabe der Lieferschein- oder Rechnungsnummer mit Datum des ursprünglichen Bezuges ist erforderlich.

Das Material muss gereinigt sein und sich in optisch und technisch einwandfreiem, verkaufsfähigem Zustand befinden. Rohmaterial wird nur in originalen Lieferlängen (ungeschnitten und unbearbeitet) zurückgenommen.

Dichtungsmaterial kann von uns aus Gewährleistungsgründen nicht zurückgenommen werden.

Für die Abwicklung von Warenrückgaben wird eine Bearbeitungsgebühr von -10% in Anrechnung gebracht.

Eventuell erforderliche Instandsetzungs- und Reinigungsarbeiten - sofern durch uns möglich - müssen wir nach Aufwand berechnen bzw. einen entsprechenden Abschlag bei der Warengutschrift vornehmen. Externe Aufwendungen werden nach tatsächlichem Kostenanfall berechnet.

Leihgeräte (PEHD-Schweissautomaten) müssen in sauberen, gereinigtem, einwandfreiem und funktionsfähigem Zustand zurückgegeben werden. Hierzu verweisen wir auch auf die Bedingungen des jeweiligen Mietvertrages.

Wir bitten für die vorstehenden Massnahmen um Ihr Verständnis, da wir zur Weiterverwendung Ihrer Retourenware auch die volle Gewährleistung übernehmen müssen.

Um eine raschestmögliche Bearbeitung Ihrer Retourenware durchführen zu können, ersuchen wir um Akzeptierung unserer dazu notwendigen organisatorischen Gegebenheiten, sowie um Information Ihrer zuständigen Mitarbeiter.